

Technics®



Operating Instructions

Network/
Super Audio CD Player

SL-G700M2

Music is borderless and timeless, touching people's hearts across cultures and generations.

Each day the discovery of a truly emotive experience from an unencountered sound awaits.

Let us take you on your journey to rediscover music.

Rediscover Music™

Technics

Delivering the Ultimate Emotive Musical Experience to All

At Technics we understand that the listening experience is not purely about technology but the magical and emotional relationship between people and music.

We want people to experience music as it was originally intended and enable them to feel the emotional impact that enthuses and delights them.

Through delivering this experience we want to support the development and enjoyment of the world's many musical cultures. This is our philosophy.

With a combination of our love of music and the vast high-end audio experience of the Technics team, we stand committed to building a brand that provides the ultimate emotive musical experience by music lovers, for music lovers.

Director
Michiko Ogawa

A handwritten signature in black ink, reading "Michiko Ogawa". The signature is fluid and cursive, with a long horizontal flourish extending to the right.

Thank you for purchasing this product.

Please read these instructions carefully before using this product, and save this manual for future use.

- About descriptions in these operating instructions
 - Pages to be referred to are indicated as “⇒ ○○”.
 - The illustrations shown may differ from your unit.
 - Unless otherwise indicated, operations are described using the remote control.
- Illustrations and figures in this manual are of the silver main body.

Sales and Support Information

Customer Communications Centre

- For customers within the UK: 0333 222 8777
- For customers within Ireland: 01 447 5229
- Monday–Friday 9:00 am – 5:00 pm, (Excluding public holidays).
- For further support on your product, please visit our website: www.technics.com/uk/

Features

Advanced Digital High Quality Audio Technology and Design Know-how

Equipped with a D/A conversion system that realises ideal characteristics of analogue audio output amplitude and phase using digital technologies, and with a power source that minimises noise in three-stage configuration combined with a high-speed switching power source and noise elimination circuit. Combining the high precision D/A conversion system created by our proprietary technology with the low noise power source achieves dynamic sound while reproducing intimate information in audio source precisely.

Support for a Variety of Digital Audio Media

Compatible with a variety of digital inputs including USB-B.

You can enjoy a wide range of digital audio media with high quality from SACDs (Super Audio CDs) to high-resolution audio and streaming services.

MQA[®] codec is also supported. Switch ON/OFF according to your preference.

High Quality Design Finished with High Rigidity Chassis, High Grade Materials, and High Build Quality

A chassis divided into four sections with reduced mutual interference between independent substrates and enhanced rigidity is employed, which includes a three-layered drive mechanism mount structure that minimises vibration transmitted to outside, and a disc tray made of aluminium die cast. In addition, a high grade design is adopted for finishing, such as a front aluminium panel with hairline machining performed in 7 mm thickness and a spin-processed knob.

Table of contents

Read first	07
------------	----

Please carefully read the "Safety precautions" of this manual before use.

Control reference guide	17
-------------------------	----

This unit, Remote control

Connections	26
-------------	----

AC mains lead connection, Network settings

Operations	40
------------	----

Playback of CD/Super Audio CD, connected device, music streaming services, etc.

Settings	88
----------	----

Sound adjustment, Other settings

Others	108
--------	-----

Troubleshooting, Specifications, etc.

Accessories

AC mains lead (3)

Except for Switzerland

K2CM3YY00041

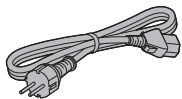

For Switzerland

K2CS3YY00048

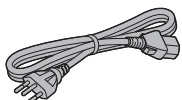

For the United Kingdom and Ireland

K2CT3YY00081

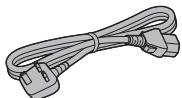

System connection cable (1)

K2KYYYY00233



Analogue audio cable (1)

K4EY4YY00003

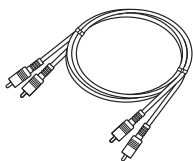

Remote control (1)

N2QAYA000240

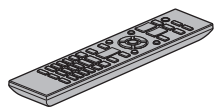

Batteries for remote control (2)



- Product numbers provided in these operating instructions are correct as of September 2022.
- These may be subject to change.
- Do not use AC mains lead with other equipment.

Read first

Safety precautions.....	08
Warning	08
Caution	08
Installation	15
Installation	15
Unit care	15
Using “Technics Audio Center”	15
Firmware updates	16
To restore all the settings to the factory defaults.....	16
To dispose of or transfer this unit	16
Network services.....	16

[↻ Table of contents ...](#) 05

Safety precautions

Warning

Unit

- To reduce the risk of fire, electric shock or product damage,
 - Do not expose this unit to rain, moisture, dripping or splashing.
 - Do not place objects filled with liquids, such as vases, on this unit.
 - Use the recommended accessories.
 - Do not remove covers.
 - Do not repair this unit by yourself. Refer servicing to qualified service personnel.
 - Do not let metal objects fall inside this unit.
 - Do not place heavy items on this unit.

AC mains lead

- To reduce the risk of fire, electric shock or product damage,
 - Ensure that the power supply voltage corresponds to the voltage printed on this unit.
 - Insert the mains plug fully into the socket outlet.
 - Do not pull, bend, or place heavy items on the lead.
 - Do not handle the plug with wet hands.
 - Hold onto the mains plug body when disconnecting the plug.
 - Do not use a damaged mains plug or socket outlet.
- The mains plug is the disconnecting device. Install this unit so that the mains plug can be unplugged from the socket outlet immediately.
- Ensure the earth pin on the mains plug is securely connected to prevent electrical shock.
 - An apparatus with CLASS I construction shall be connected to a mains socket outlet with a protective earth connection.

Caution

Unit

- Do not place sources of naked flames, such as lighted candles, on this unit.
- This unit may receive radio interference caused by mobile telephones during use. If such interference occurs, please increase separation between this unit and the mobile telephone.
- This unit is intended for use in moderate and tropical climates.
- Do not put any objects on this unit. This unit becomes hot while it is on.
- This unit utilizes a laser. Use of controls or adjustments or performance of procedures other than those specified herein may result in hazardous radiation exposure.

Placement

- Place this unit on an even surface.
- To reduce the risk of fire, electric shock or product damage,
 - Do not install or place this unit in a bookcase, built-in cabinet or in another confined space. Ensure this unit is well ventilated.
 - Do not expose this unit to direct sunlight, high temperatures, high humidity, and excessive vibration.
- Do not lift or carry this unit by holding the knobs or antenna. Doing so may cause this unit to fall, resulting in personal injury or malfunction of this unit.

Battery

- Danger of explosion if battery is incorrectly replaced. Replace only with the type recommended by the manufacturer.
- Mishandling of batteries can cause electrolyte leakage and may cause a fire.
 - Remove the battery if you do not intend to use the remote control for a long period of time. Store in a cool, dark place.
 - Do not heat or expose to flame.
 - Do not leave the battery(ies) in a car exposed to direct sunlight for a long period of time with doors and windows closed.
 - Do not take apart or short circuit.
 - Do not recharge alkaline or manganese batteries.
 - Do not use batteries if the covering has been peeled off.
 - Do not mix old and new batteries or different types at the same time.
- When disposing of the batteries, please contact your local authorities or dealer and ask for the correct method of disposal.
- Avoid the use in the following conditions
 - High or low extreme temperatures during use, storage or transportation.
 - Replacement of a battery with an incorrect type.
 - Disposal of a battery into fire or a hot oven, or mechanically crushing or cutting of a battery, that can result in an explosion.
 - Extremely high temperature and/or extremely low air pressure that can result in an explosion or the leakage of flammable liquid or gas.

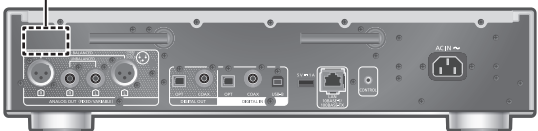

(Back of product)

CAUTION	- VISIBLE AND INVISIBLE LASER RADIATION WHEN OPEN. DO NOT STARE INTO BEAM. FDA 21CFR / CLASS II (IIa)
CAUTION	- CLASS 2 VISIBLE AND INVISIBLE LASER RADIATION WHEN OPEN. DO NOT STARE INTO THE BEAM. IEC60825-1:2007 / CLASS 2
ATTENTION	- RAYONNEMENT LASER VISIBLE ET INVISIBLE, CLASSE 2, EN CAS D'OUVERTURE. NE PAS REGARDER DANS LE FAISCEAU.
VARNING	- KLASS 2 SYNLLIG OCH OSYNLLIG LASERSTRÅLNING NÄR DENNA DEL ÄR ÖPPNAD. STIRRA EJ IN I STRÅLEN.
FORSIGTIG	- SYNLLIG OG USYNLLIG LASERSTRÅLNING KLASSE 2, NÄR LÅGET ER ÅBENT. UNDGÅ AT SE LIGE IND I STRÅLEN.
VARO	- AVATTAESSA OLET ALTTIINA LUOKAN 2 NÄKYVÄÄ JA NÄKYMÄTÖNTÄ LASERSÄTEILYÄ. ÄLÄ TUJOTA SÄTEESEEN.
VORSICHT	- SICHTBARE UND UNSICHTBARE LASERSTRAHLUNG KLASSE 2, WENN ABDECKUNG GEÖFFNET. NICHT IN DEN STRAHL BLICKEN.
注意	- ここを開くとクラス2の可視及び不可視レーザー放射が出ます。ビームをのぞき込まないでください。 TQFX0089

(Inside of product)
(Produktets inside)

For the United Kingdom and Ireland customer

Caution for AC Mains Lead

(For the AC mains plug of three pins)

For your safety, please read the following text carefully.

This appliance is supplied with a moulded three pin mains plug for your safety and convenience.

A 10-ampere fuse is fitted in this plug.

Should the fuse need to be replaced please ensure that the replacement fuse has a rating of 10-ampere and that it is approved by ASTA or BSI to BS1362.

Check for the ASTA mark  or the BSI mark  on the body of the fuse.

If the plug contains a removable fuse cover you must ensure that it is refitted when the fuse is replaced.

If you lose the fuse cover the plug must not be used until a replacement cover is obtained.

A replacement fuse cover can be purchased from your local dealer.

Before use

Remove the connector cover.

How to replace the fuse

The location of the fuse differ according to the type of AC mains plug (figures A and B). Confirm the AC mains plug fitted and follow the instructions below. Illustrations may differ from actual AC mains plug.

1. Open the fuse cover with a screwdriver.

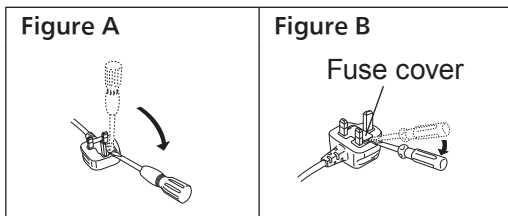

2. Replace the fuse and close or attach the fuse cover.

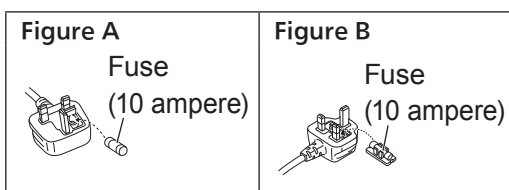

NORSK

ADVARSEL

Produkt

- For å redusere faren for brann, elektrisk støt eller skade på apparatet :
 - Utsett ikke produktet for regn, fukt, drypping eller sprut.
 - Ikke plasser objekter som er fylt med væske, som vaser, på apparatet.
 - Bruk anbefalt tilbehør.
 - Fjern ikke deksler.
 - Reparer ikke denne enheten selv, overlat service til kvalifisert servicepersonell.

Vekselstrømnett

- Nettstøpselet er trukket ut fra denne enheten. Installer denne enheten slik at nettstøpselet umiddelbart kan trekkes fra stikkontakten.

FORSIKTIG

Produkt

- Dette produktet anvender en laser. Betjening av kontroller eller justering eller andre inngrep enn de beskrevet i denne bruksanvisning kan føre til farlig bestråling.
- Plasser ikke åpen ild, slik som levende lys, oppå apparatet.
- Denne enheten er beregnet for bruk i moderate og tropiske klimaer.

Plassering

- For å redusere faren for brann, elektrisk støt eller skade på apparatet :
 - Ikke plasser apparatet i en bokhylle, et innebygget kabinett eller et annet lukket sted. Pass på at produktet er godt ventilert.

Disposal of Old Equipment and Batteries Only for European Union and countries with recycling systems



These symbols on the products, packaging, and/or accompanying documents mean that used electrical and electronic products and batteries must not be mixed with general household waste.

For proper treatment, recovery and recycling of old products and used batteries, please take them to applicable collection points in accordance with your national legislation.

By disposing of them correctly, you will help to save valuable resources and prevent any potential negative effects on human health and the environment.

For more information about collection and recycling, please contact your local authority.

Penalties may be applicable for incorrect disposal of this waste, in accordance with national legislation.



Note for the battery symbol (bottom symbol):

This symbol might be used in combination with a chemical symbol. In this case it complies with the requirement set by the Directive for the chemical involved.

Panasonic Corporation, a company having its registered office of 1006, Oaza Kadoma, Kadoma City, Osaka 571-8501, Japan, automatically collects personal data such as IP address and/or Device ID from your device as soon as you connect it to the Internet. We do this to protect our customers and the integrity of our Service as well as to protect the rights or property of Panasonic.

You have a right of access, rectification and objection to in certain circumstances, a right of erasure, restriction of processing, data portability and a right to object to other forms of processing. If you wish to exercise any of the above rights and/or wish to know more about the processing of your personal data in this context, please refer to the full text of our privacy policy displayed at the support page of your device, <http://panasonic.jp/support/global/cs/audio/>, <http://www.technics.com/support/> or contact our customer communications/support number or address described in the Pan European Guarantee included in your device box to send you the full text of our privacy policy.

EU Declaration of Conformity (DoC)

Hereby, "Panasonic Corporation" declares that this product is in compliance with the essential requirements and other relevant provisions of Directive 2014/53/EU.

Customers can download a copy of the original DoC to our RE products from our DoC server:

<https://www.ptc.panasonic.eu>

Contact to Authorised Representative:

Panasonic Marketing Europe GmbH, Panasonic Testing Centre, Winsbergring 15, 22525 Hamburg, Germany

Indoor use: Inside buildings only. Installations and use inside road vehicles and train carriages are not permitted. Limited outdoor use: If used outdoors, equipment shall not be attached to a fixed installation or to the external body of road vehicles, a fixed infrastructure or a fixed outdoor antenna. Use by unmanned aircraft systems (UAS) is limited to within the 5170 - 5250 MHz band.

Frequency band: 5250 - 5350 MHz:

Indoor use: Inside buildings only. Installations and use in road vehicles, trains and aircraft are not permitted. Outdoor use is not permitted.

Frequency band: 5470 - 5725 MHz:

Installations and use in road vehicles, trains and aircraft and use for unmanned aircraft systems (UAS) are not permitted.

The above restrictions apply to the following countries:

AT	BE	BG	CZ	DK	EE	FR	DE	IS
IE	IT	EL	ES	CY	LV	LI	LT	LU
HU	MT	NL	NO	PL	PT	RO	SI	SK
TR	FI	SE	CH	UK(NI)	HR			

UK Declaration of Conformity (DoC)

Hereby, "Panasonic Corporation" declares that this product is in compliance with the essential requirements and other relevant provisions of the Radio Equipment Regulations 2017 No.1206.

Customers can download a copy of the original DoC to our RE products from our DoC server:

<https://www.ptc.panasonic.eu/compliance-documents>

Contact in the UK : Panasonic Testing Centre on behalf of Panasonic UK, a branch of Panasonic Marketing Europe GmbH (Importer) Maxis 2, Western Road, Bracknell, Berkshire, RG12 1RT

Frequency band: 5150 - 5250 MHz:

Indoor use: Inside buildings only. Installations and use inside road vehicles and train carriages are not permitted. Limited outdoor use: If used outdoors, equipment shall not be attached to a fixed installation or to the external body of road vehicles, a fixed infrastructure or a fixed outdoor antenna. Use by unmanned aircraft systems (UAS) is limited to within the 5170 - 5250 MHz band.

Frequency band: 5250 - 5350 MHz:

Indoor use: Inside buildings only. Installations and use in road vehicles, trains and aircraft are not permitted. Outdoor use is not permitted.

Frequency band: 5470 - 5725 MHz:

Installations and use in road vehicles, trains and aircraft and use for unmanned aircraft systems (UAS) are not permitted.

The above restrictions apply to the United Kingdom.

Type of wireless	Frequency band	Maximum power (dBm e.i.r.p.)
WLAN	2412 - 2472 MHz	18 dBm
	5180 - 5320 MHz	18 dBm
	5500 - 5700 MHz	18 dBm
	5745 - 5825 MHz	14 dBm
Bluetooth®	2402 - 2480 MHz	4 dBm

Installation

Installation

- Eject a CD, fold the antenna and turn off all the equipment before connection and read the appropriate operating instructions. Be sure to raise this unit when moving, and do not drag this unit.
- Confirm the installation location can sustain the weight of this unit. (⇒ 127)
- For the dimensions of this unit (⇒ 127)
- Refer to the following figure for the dimensions of this unit's legs.

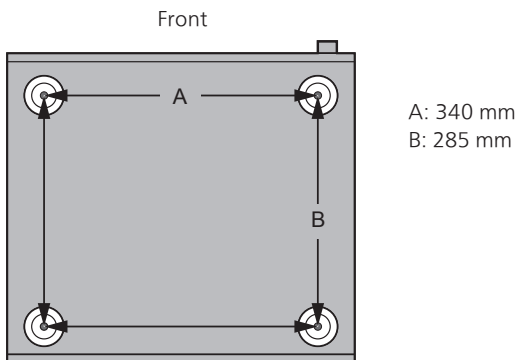

Unit care

Pull out the AC mains lead from the socket before maintenance. Clean this unit with a soft cloth.

- When dirt is heavy, wring a wet cloth tightly to wipe the dirt, and then wipe it with a soft cloth.
- Do not use solvents including benzene, thinner, alcohol, kitchen detergent, chemical wiper, etc. Doing so may cause the exterior case to be deformed or the coating to come off.

Using "Technics Audio Center"

If you install the dedicated app "Technics Audio Center" (free of charge) on your tablet/smartphone, you can stream music files from the device on your network to this unit and configure the settings of sound quality, etc.

For details, visit:

www.technics.com/support/

- This application is subject to change or be discontinued with notice.

Firmware updates

Occasionally, Panasonic may release updated firmware for this unit that may add or improve the way a feature operates. These updates are available free of charge.

- Refer to “Firmware updates” (⇒ 97) for details on update.

To restore all the settings to the factory defaults

- ① Press [NWP] while this unit is turned on.
- ② Press [SETUP].
- ③ Press [▲], [▼] repeatedly to select “Initialization” and then press [OK].
- ④ Press [▲], [▼] to select “Yes” and then press [OK].
 - A confirmation screen appears. Select “Yes” in the following steps to restore all the settings to defaults.
- ⑤ Press [▲], [▼] to select “Yes” and then press [OK] again.

To dispose of or transfer this unit

- Before disposing of or transferring this unit, be sure to erase all the recorded information by restoring the settings to factory default (above).
- Before you dispose of or transfer this unit to a third party, be sure to log out of your music streaming services accounts to prevent unauthorised use of your accounts.

Network services

The services provided by their respective service providers may be changed or discontinued without notice. Panasonic bears no responsibility for change or discontinuance of their services.

Not all music streaming services are available in all countries/regions. Registration/subscription may be required, or fees may be charged to use music streaming services. Services are subject to change or be discontinued. For details, visit an individual music streaming service’s website.

Control reference guide

This unit (front)	18
This unit (rear)	20
Remote control	21
Using the remote control	24
Remote control mode	24

[↻ Table of contents ...](#) 05

This unit (front)

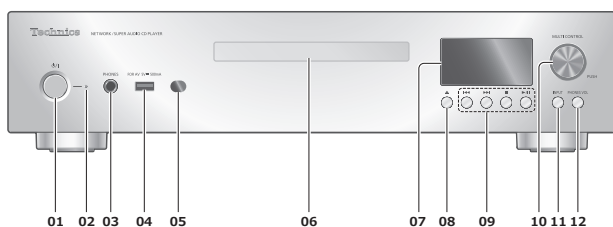

01 [⏻/⏻] Standby/on button

- Press to switch the unit from on to standby mode or vice versa. In standby mode, the unit is still consuming a small amount of power.

02 Power indicator

- Blue: The unit is on.
- Off: The unit is off.
- Red: The unit is in standby mode.

03 Headphones jack

- Excessive sound pressure from earphones and headphones can cause hearing loss.
- Listening at full volume for long periods may damage the user's ears.

04 USB-A terminal (USB-A Front) (For AV) (DC 5 V \equiv 500 mA)

(⇒ 47)

05 Remote control signal sensor

- Reception distance:
Within approx. 7 m directly in front
- Reception angle:
Approx. 30° left and right

06 Disc tray

(⇒ 43)

07 Display

- Input source, playback status, etc. are displayed.

08 [▲] Open or close the disc tray

09 Playback operation buttons

(e.g. "CD")

Stop	[■]
Pause	[▶/] • Press again to resume.
Skip	[◀◀] [▶▶]
Search	Press and hold [◀◀] or [▶▶].

10 Multi control knob

- Turn this knob clockwise or anticlockwise to switch the input source and scroll through items.
- To enter the setup screen, press and hold the knob. (Press knob to set an item on the screen.)

11 Input selector button

- Switch the input source.

12 Headphone volume button

- Headphone volume is displayed.
 - Volume can be adjusted with the multi control knob while displaying. (The volume buttons of remote control are not available for adjusting the headphone volume.)
 - Press and hold the headphone volume button while displaying to keep the headphone volume adjusting screen displaying. Press again to exit.
- Volume range:
 - dB (min), -99.0 dB to 0 dB (max)
- Set "PHONES VOL Limitation" to "On" so that the headphones output is automatically lowered if the volume is extremely high when turning this unit or starting playback. (⇒ 93)
- Press 2 times to display the analogue output level screen to adjust while "A.Output Level" is set to "Variable". (⇒ 92)
 - Press and hold the headphone volume button while the output level is displayed to keep the screen displaying. Press again to exit.

This unit (rear)

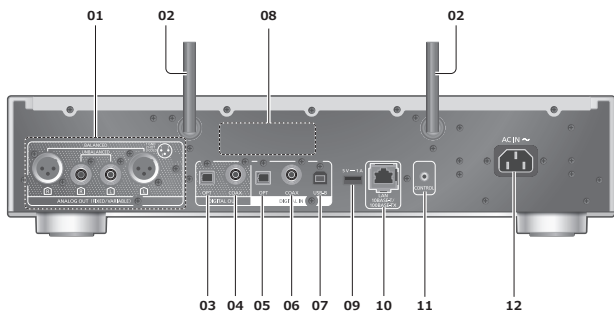

01 Analogue audio output terminals (ANALOG OUT)

(⇒ 27)

02 Wireless LAN antenna

(⇒ 33)

03 Optical digital output terminal (OPT)

(⇒ 28)

04 Coaxial digital output terminal (COAX)

(⇒ 28)

05 Optical digital input terminal (OPT)

(⇒ 51)

06 Coaxial digital input terminal (COAX)

(⇒ 51)

07 USB-B terminal (USB-B)

(⇒ 53)

- For connecting to a PC, etc.

08 Product identification marking

- The model number is indicated.

09 USB-A terminal (USB-A Rear)

(DC 5 V \equiv 1 A)

(⇒ 47)

10 LAN terminal

(⇒ 32)

11 System terminal (CONTROL)

(⇒ 105)

12 AC IN terminal (~)

(⇒ 29)

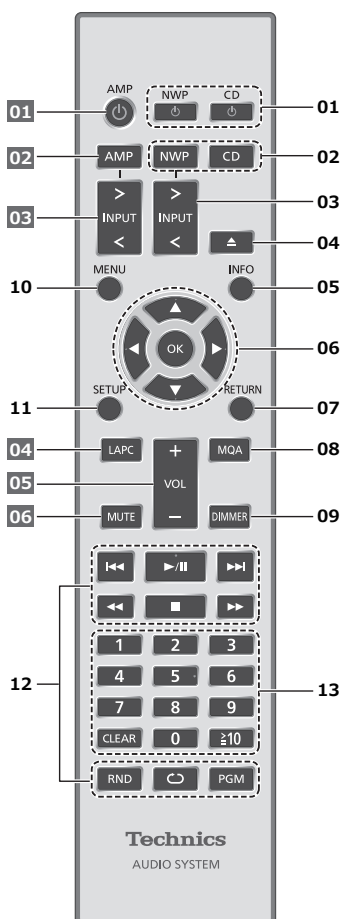

■ Buttons that work for this unit

01 [NWP - Press to switch the unit from on to standby mode or vice versa. In standby mode, the unit is still consuming a small amount of power. The input source also switches for each selector (switches to the last selected input source when [NWP 02 [NWP]/[CD]: Select the device to be operated

- The current playing layer is displayed by pressing [CD] while the playback stops for Hybrid Super Audio CD (SACD). Press again to switch the layer.
- Press and hold [CD] to switch to “Pure Disc Playback” mode. (⇒ 46)

03 [>INPUT<]: Switch the input source

04 [21

05 [INFO]: View content information*1

- The sound setting information is displayed such MQA Decoding, etc. by pressing and holding [INFO].

06 [▲], [▼], [◀], [▶]/[OK]: Selection/OK*1

07 [RETURN]: Return to the previous display*1

08 [MQA]: Switches MQA decoding function to "On"/"Off"

- "MQA Decoding : On" is displayed when the function is "On".
- Press repeatedly to switch the function.

09 [DIMMER]: Adjust the brightness of the power indicator, display, etc.

- When the display is turned off, it will light up for a few seconds only when you operate this unit. Before the display turns off, "Display Off" will be displayed for a few seconds.
- Press repeatedly to switch the brightness.

10 [MENU]: Enter menu*1

11 [SETUP]: Enter setup menu*1

(⇒ 90)

12 Playback control buttons

(⇒ 44, 48, 57, 61, 65, 71, 75, 79, 82, 87)

- You can register station, music or playlist to your favourites (FAV) by pressing and holding [PGM]. (⇒ 103)

13 Numeric buttons, etc.

- To enter 2 digits or more

Example:

16: [≧ 10] > [1] > [6]

124: [≧ 10] > [≧ 10] > [1] > [2] > [4]

- [CLEAR]: Clear the entered value.

*1: Press [NWP] first to operate this unit. (The remote control works only for the devices supporting system control function when pressing [AMP].)

■ Buttons that work for the connected Technics devices

The remote control of this unit also works for Technics devices (Stereo Integrated Amplifier, etc.). For information on the operations of the devices, please also refer to their operating instructions.

- 01 [] Standby/on button
- 02 Select the device to be operated
- 03 Switch the input source
- 04 Measure the output signal when speakers are connected, and correct its output
- 05 Adjust the volume*2
- 06 Mute the sound*2

*2: Also works while "A.Output Level" is set to "Variable". (⇒ 92)

Using the remote control

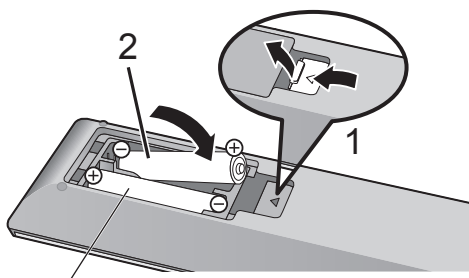

R03/LR03, AAA
(Alkaline or manganese batteries)

Note

- Insert the battery so the terminals (\oplus and \ominus) match those in the remote control.
- Point it at the remote control signal sensor on this unit. (\Rightarrow 18)
- Keep the batteries out of reach of children to prevent swallowing.

Remote control mode

When other equipment responds to the supplied remote control, change the remote control mode.

- The factory default is "Mode 1".

1 Press [NWP].

2 Press [SETUP].

3 Press [\blacktriangle], [\blacktriangledown] to select "Remote Control" and then press [OK].

- The current remote control mode of this unit is displayed.

4 When "Set Mode 1/2" is displayed, change the remote control mode of the remote control.

To set "Mode 1":

Press and hold [OK] and [1] for at least 4 seconds.

To set "Mode 2":

Press and hold [OK] and [2] for at least 4 seconds.

5 Point the remote control at this unit, and press and hold [OK] for at least 4 seconds.

- When the remote control mode is changed, the new mode will appear on the display for a few seconds.

■ **When “Remote 1” or “Remote 2” is displayed**

When “Remote 1” or “Remote 2” is displayed, the remote control modes of this unit and remote control are different. Perform step 4 above.

Connections

Connecting to an amplifier	27
Connecting to an amplifier	27
Connecting to an amplifier with digital input terminal.....	28
Connecting to an amplifier with digital input terminal.....	28
AC mains lead.....	29
AC mains lead connection	29
Network settings	30
Wired LAN connection.....	32
Wireless LAN connection	33
This unit's name on the network "Friendly Name"	39
To check the MAC address of this unit "MAC Address"	39

[↶ Table of contents ...](#) 05

Connecting to an amplifier

You can output analogue audio signals from this unit and play back music.

Connecting to an amplifier

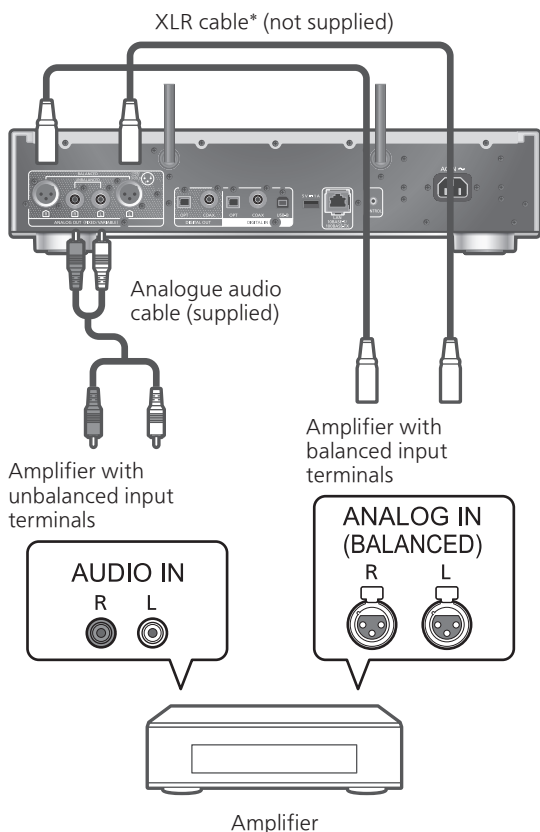

*: We recommend using cables with a length of 3 m or less.

- For details, refer to the operating instructions of the connected device.
- Do not use any other analogue audio cables except the supplied one.
- When you connect a power amplifier, etc., set "A.Output Level" to "Variable" for volume control with this unit. When you connect a pre-amplifier, etc., set "A.Output Level" to "Fixed" for volume control with the connected device. (⇒ 92)
 - The factory default is "Fixed".

Connecting to an amplifier with digital input terminal

You can output digital audio signals from this unit by connecting to an amplifier with digital input terminal, etc. and play back music.

Connecting to an amplifier with digital input terminal

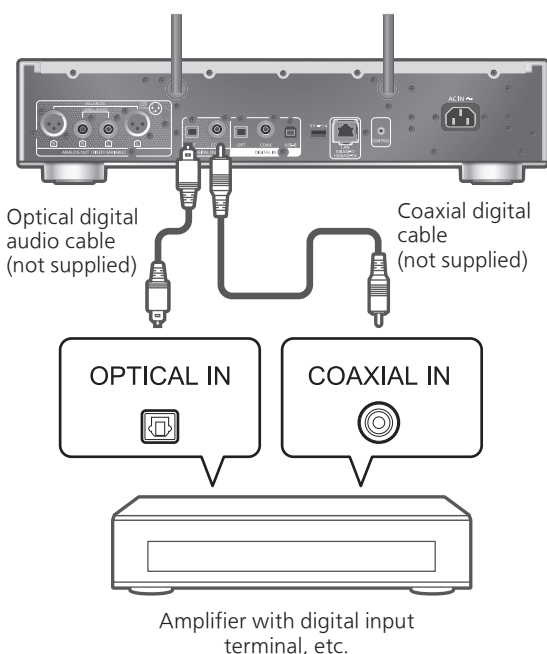

- For details, refer to the operating instructions of the connected device.

Note

- Audio signal of Super Audio CD and Super Audio CD layer of Hybrid Super Audio CD cannot be output from the digital audio output terminal of this unit. Connect the device to the analogue audio output terminal.
- When enjoying video contents with this function, the video and audio output may not be synchronised.

AC mains lead

AC mains lead connection

Connect only after all other connections are completed.

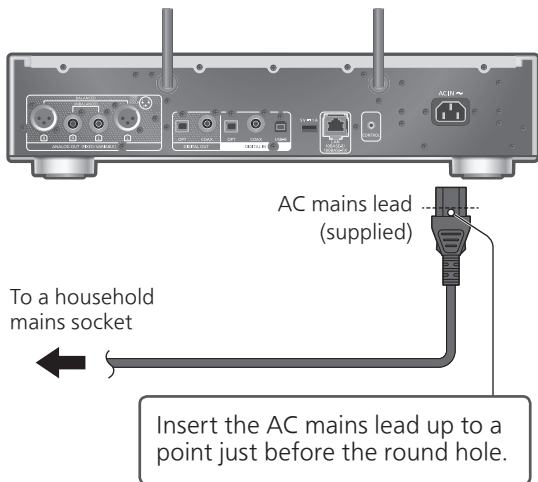

- Use only the supplied AC mains lead.
- Insert the plugs of the cables to be connected all the way in.
- Do not bend cables at sharp angles.
- Wireless LAN (Wi-Fi®) setting may start when this unit is turned on. If you stop the Wi-Fi setting, select "No" in "Wi-Fi Setup" screen. Select "Yes" to keep the Wi-Fi setting. (⇒ 33)
- Press [NWP] first to operate this unit.

Note

- This unit consumes a small amount of AC power (⇒ 127) even when the unit is in standby mode. Remove the plug from the main electrical outlet if you will not be using the unit for an extended period of time. Place the unit so the plug can be easily removed.

Network settings

You can stream online music services or music files from your smartphone/tablet to this unit. To use these features, this system must join the same internet-connected network as the compatible device.

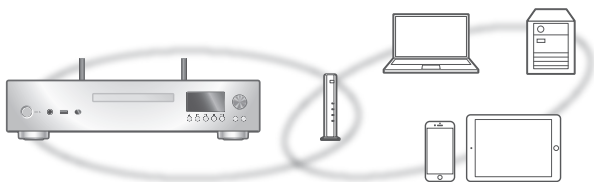

This unit can be connected to a router using a LAN cable or built-in Wi-Fi®.

For a stable connection to the network, a wired LAN connection is recommended.

Note

- If you try to change the network settings immediately after turning on this unit, it may take some time until the network setup screen is displayed.
- If “Firmware update is available” is displayed after the network connection is set up, the firmware for this unit is available.
 - Refer to “Firmware updates” (⇒ 97) for details on update.
 - For the update information, refer to the following website.
www.technics.com/support/firmware/
- In order to fully enjoy all the features the SL-G700M2 has to offer, it has been designed to work with the Google Home app which integrates with your Google account.

■ Preparation

If you install the Google Home app or Apple Home app on your smartphone/tablet, you can set up a connection using the application.

- When using Chromecast-enabled apps to play music on this unit, set up a connection using the Google Home app and a Google Assistant-enabled device.
- When using AirPlay to play music on this unit, add the product to Home in the Apple Home app. Adding this unit to the network via Apple Home app will also allow the user to stream audio using Siri.
- Make sure that the Wi-Fi function and Bluetooth® function are activated on your smartphones/tablet.

(Using Google Home app)

1 Install the Google Home app on your smartphone/tablet.

- To download the Google Home app, visit:
<https://www.google.com/cast/setup/>



(Using Apple Home app)

1 Install Apple Home app on your smartphone/tablet.

- To download Apple Home app, visit:
<https://www.apple.com/ios/home/>





2 Connect your smartphone/tablet to the same network as this unit before setting.

- Make sure that the network is connected to the Internet.

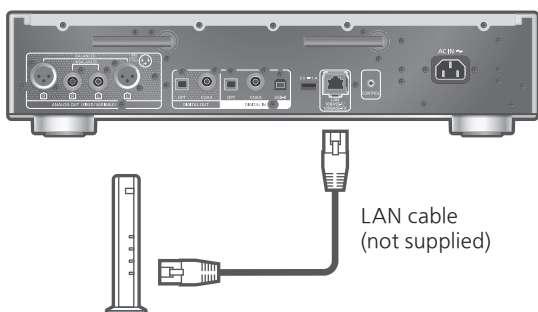
Wired LAN connection



Broadband router, etc.

- 1 Disconnect the AC mains lead.**
- 2 Connect this unit to a broadband router, etc. using a LAN cable.**
- 3 Connect the AC mains lead to this unit.**
(⇒ 29)
- 4 Press [NWP ] to turn this unit on.**
 - When the connection is established, "" is displayed.
- 5 Press [>INPUT<] to select "Chromecast built-in".**
(Using Google Home app)
- 6 Open the Google Home app and follow the on-screen instructions to set up a connection.** (⇒ 37)
(Using Apple Home app)
- 6 Open Apple Home app and follow the on-screen instructions to set up a connection.** (⇒ 36)

Note

- While the AC mains lead is disconnected, the LAN cable must be connected or disconnected.
- Use category 7 or above straight LAN cables (STP) when connecting to peripheral devices.
- Inserting any cable other than a LAN cable in the LAN port can damage the unit.
- When a LAN cable is connected, the Wi-Fi function may be disabled.

Wireless LAN connection

■ Preparation

- ① Disconnect the AC mains lead.
- ② Disconnect the LAN cable.
- ③ Place this unit as close to the wireless router as possible.
- ④ Point up the antenna on the rear of this unit as shown in the figure.

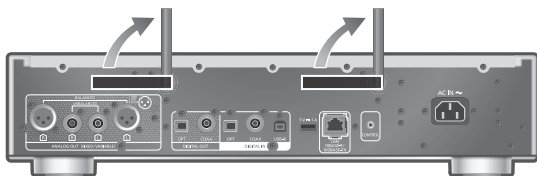

- ⑤ Connect the AC mains lead to this unit. (⇒ 29)

Note

- The setting will be cancelled after the set time limit. In that case, try the setting again.
- To cancel this setting in the middle, press [■] or turn the unit to standby mode.
- When the connection is established, "📶" is displayed. (⇒ 37)

Network setting for the first time using the app

1 Press [NWP ⏻] to turn this unit on.

- "Wi-Fi Setup" is displayed.

2 Press [▲], [▼] to select "Yes" and press [OK].

- "Setting" is displayed.

(Using Google Home app)

3 Open the Google Home app and follow the on-screen instructions. (⇒ 37)

(Using Apple Home app)

3 Open Apple Home app and follow the on-screen instructions to set up a connection. (⇒ 37)

Note

- This unit will be displayed as “Technics-SL-G700M2-****” if the device name is not set. (“****” stands for characters unique to each set.)
- You can check your network information (SSID, MAC address and IP address) from the Google Home app or “Technics Audio Center” app.
- Some items on the Google Home app are irrelevant to this unit.
- When this unit is switched to standby mode and turned on before the Wi-Fi setting is complete, “Wi-Fi Setup” is displayed. Complete the Wi-Fi setting or set “Wi-Fi Menu” to “Off” to turn off the display.

Setting the network from the setup menu (When not using apps with this unit)

- To stream music files with this unit using Chromecast-enabled apps (⇒ 37), set up the network setting using Google Home app. (⇒ 36)

■ Using the WPS button “WPS”

If your wireless router supports WPS, you can set up a connection by pressing the WPS button.

- A compatible wireless router may have the WPS identifier mark.
- Complete the settings within 2 minutes while “WPS” is displayed.
- When “Wi-Fi Setup” is displayed when turning on this unit, press [■] to cancel the network setting and start the setting again.

1 Press [NWP].

2 Press [SETUP].

3 Press [▲], [▼] repeatedly to select “Network” and then press [OK].

- When “Wi-Fi Menu” screen is displayed, press [OK].

4 Press [▲], [▼] to select “On” and then press [OK]. (The wireless LAN function is enabled.)

5 Press [▲], [▼] to select “WPS Push” and then press [OK].

- “WPS” blinks. Complete step 6 within 2 minutes.

6 After “WPS” is displayed, press the WPS button on the wireless router.

Example:

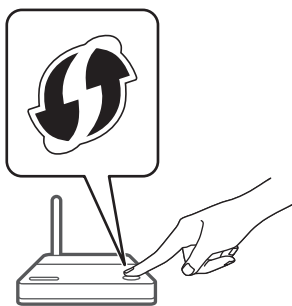

- “Linking” blinks.
- When the connection is established, “Success” is displayed.
 - “Fail” may be displayed if the connection was not complete. Try this method again from the setup menu. If “Fail” is still displayed, try other methods.

7 Press [OK] to exit the setting.

■ Using the WPS PIN code “WPS PIN”

If your wireless router supports WPS, you can set up a connection by entering the WPS PIN code.

- For details on how to enter the PIN code, refer to the operating instructions of the wireless router.
- Complete the settings within 2 minutes while “WPS PIN” and the PIN code are displayed.
- When “Wi-Fi Setup” is displayed when turning on this unit, press [■] to cancel the network setting and start the setting again.

1 Press [NWP].

2 Press [SETUP].

3 Press [▲], [▼] repeatedly to select “Network” and then press [OK].

- When “Wi-Fi Menu” screen is displayed, press [OK].

4 Press [▲], [▼] to select “On” and then press [OK]. (The wireless LAN function is enabled.)

5 Press [▲], [▼] to select “WPS PIN” and then press [OK].

- The PIN code is displayed. Complete step 6 within 2 minutes.

6 Enter the PIN code into the wireless router from PC, etc.

- “Linking” blinks.
- When the connection is established, “Success” is displayed.
 - “Fail” may be displayed if the connection was not complete. Try this method again from the setup menu. If “Fail” is still displayed, try other methods.

7 Press [OK] to exit the setting.

Note

- Depending on a router, other connected devices may temporarily lose their connection.
- For details, refer to the operating instructions of the wireless router.

Setting the network from the setup menu (When using app with this unit)

1 Press [NWP].

2 Press [>INPUT<] to select “Chromecast built-in”.

3 Press [SETUP].

4 Press [▲], [▼] repeatedly to select “Network” and then press [OK].

- When “Wi-Fi Menu” screen is displayed, press [OK].

5 Press [▲], [▼] to select “On” and then press [OK]. (The wireless LAN function is enabled.)

6 Press [▲], [▼] to select “Wi-Fi Setup” and then press [OK].

- “Setting” is displayed.

(Using Google Home app)

7 Open the Google Home app and follow the on-screen instructions to set up a connection.

(Using Apple Home app)

7 Open Apple Home app and follow the on-screen instructions to set up a connection.

■ Using the Google Home app or Apple Home app

“Wi-Fi Setup”

1 Open the Google Home app or Apple Home app and follow the on-screen instructions to set up a connection.

- When the connection is established, “Success” is displayed.
 - “Fail” may be displayed if the connection was not complete. Try this method again from the setup menu. If “Fail” is still displayed, try other methods.

2 Press [OK] to exit the setting.

Note

- This unit will be displayed as “Technics-SL-G700M2-****” if the device name is not set. (“****” stands for characters unique to each set.)
- You can check your network information (SSID, MAC address and IP address) from the Google Home app or “Technics Audio Center” app.
- Some items on the Google Home app are irrelevant to this unit.

Streaming music over the network

This unit is compatible with Chromecast-enabled apps. For detailed information of Chromecast-enabled apps, visit:

g.co/cast/apps

You can also stream music files from the device on your network to this unit by using the “Technics Audio Center” app. Download and install the app from the website below.

www.technics.com/support/

■ Preparation

- Complete the network settings. (⇒ 30)
(Make sure that the network is connected to the Internet.)
- Install the supported application on your device.
- Connect the device to the network currently used at home.

1 Open a Chromecast-enabled app, AirPlay-enabled app (⇒ 86) or “Technics Audio Center” app on your device (smartphone, tablet, etc.), and select this unit as the output speaker.

2 Play back the music.

Note

- You cannot use Chromecast app with this unit when the network setting is set up by “WPS PIN” for “WPS Push”. To stream music files with this unit using Chromecast-enabled apps (⇒ 37), set up the network setting using Google Home app. (⇒ 36)

Not all music streaming services are available in all countries/regions. Registration/subscription may be required, or fees may be charged to use music streaming services. Services are subject to change or be discontinued. For details, visit an individual music streaming service’s website.

Important notice:

Before you dispose of or transfer this unit to a third party, be sure to log out of your music streaming services accounts to prevent unauthorised use of your accounts.

This unit's name on the network "Friendly Name"

You can change this unit's name on the network (e.g. "Room 1" or "Living Room" etc.).

- 1 Press [NWP].
- 2 Press [SETUP].
- 3 Press [▲], [▼] repeatedly to select "Network" and then press [OK].
- 4 Press [▲], [▼] repeatedly to select "Friendly Name" and then press [OK].
 - The current name of this unit is displayed. Press [OK] to edit.
- 5 Press [▲], [▼], [◀], [▶] to input the friendly name.
 - Only ASCII characters can be used.
 - "A" can be added when you press the [▶] at the time of the last letter of the Friendly Name is selected.
 - Press [CLEAR] to delete a letter.
 - Press [≥10] to insert a letter "A".
 - Default name is "Technics-SL-G700M2-****". "****" stands for a number that is unique to each set.
- 6 Press [OK] to apply the settings.
- 7 Press [RETURN] to exit the settings.
 - When Friendly Name is not displayed properly, delete and input the friendly name again. If the problem still persists, restore all the settings to the factory defaults. (⇒ 110)

To check the MAC address of this unit "MAC Address"

- 1 Press [NWP].
- 2 Press [SETUP].
- 3 Press [▲], [▼] repeatedly to select "Network" and then press [OK].
- 4 Press [▲], [▼] repeatedly to select "MAC Address" and then press [OK].
 - The MAC address of this unit is displayed.
- 5 Press [RETURN] to exit the screen.

Operations

Playing back CD/Super Audio CD	43
Operations during playback	44
Repeat playback.....	44
Random playback.....	44
Programme playback	44
Playing back Hybrid Super Audio CDs.....	45
Pure Disc Playback	46
Using USB device	47
Using a USB HDD	47
Operations during playback	48
Repeat playback.....	48
Random playback.....	48
Add a track to playlist.....	49
Calling up the playlist	49
Deleting the track from playlist	50
Using digital audio output device	51
Using PC, etc.	53
Using USB 2.0 cable	54
Using Bluetooth®	55
Pairing a Bluetooth® device	55
Operations during playback	57
Disconnecting a Bluetooth® device.....	57
Bluetooth® transmission mode	58
Automatically connects to the last connected Bluetooth® device "Auto Reconnect"	58
Playing back music more natural-sounding audio "RE-MASTER"	59

Playing back music files on the media server.....	60
Playing back content stored on the media server by controlling it from this unit	61
Operations during playback	61
Repeat playback.....	62
Random playback.....	62
Operations using the dedicated app “Technics Audio Center”	62
Playing back content stored on the media server by controlling it from a DMC.....	63
Playing Internet Radio and Podcasts.....	64
Operations during playback	65
Repeat playback.....	65
Random playback.....	65
Adding a station to favourite list “Add Favourites”	66
Call up the favourite track/album/artist.....	66
Deleting the favourite station “Delete Favourites”	66
Operations using the dedicated app “Technics Audio Center”	67
Playing audio using Spotify Connect	68
Using TIDAL.....	70
Operations during playback	71
Repeat playback.....	71
Random playback.....	72
Adding a track/album/artist, etc. to favourite list “Add Favourites”	72
Call up the favourite track/album/artist.....	72
Deleting the track/album/artist “Delete Favourites”	73
Operations using the dedicated app “Technics Audio Center”	73
Using Deezer	74
Operations during playback	75
Repeat playback.....	75
Random playback.....	76
Adding a track/album/artist, etc. to favourite list “Add Favourites”	76
Call up the favourite track/album/artist.....	76
Deleting the track/album/artist “Delete Favourites”	77
Operations using the dedicated app “Technics Audio Center”	77



Using Amazon Music	78
Operations during playback	79
Repeat playback.....	79
Random playback.....	80
Operations using the dedicated app "Technics Audio Center"	80
Using Qobuz.....	81
Operations during playback	82
Repeat playback.....	82
Random playback.....	83
Adding a track/album/artist, etc. to favourite list "Add Favourites"	83
Call up the favourite track/album/artist....	83
Deleting the track/album/artist "Delete Favourites"	84
Operations using the dedicated app "Technics Audio Center"	84
Listening to music using Chromecast-enabled app	85
Using AirPlay	86
Operations during playback	87

 [Table of contents ...](#) 05

Playing back CD/Super Audio CD

Insert the CD for music playback.

- Refer to “Notes on discs” (⇒ 122) for the discs this unit can play back.

- 1 Press [NWP ]/[CD ] to turn this unit on.
- 2 Press [>INPUT<] repeatedly to select “CD”.
- 3 Press [] to open the disc tray and insert a CD.
 - Place label up in the proper position in the middle of the disc tray.

12 cm CD

DO



DO NOT





8 cm CD

DO



DO NOT



- This unit turns on and input source is switched to “CD” by pressing [] while this unit is turned off.
- Press [] again to close the disc tray.

4 Press [].

- The current playing layer is displayed by pressing [CD] while the playback stops for Hybrid Super Audio CD (SACD). Press again to switch the layer.

Note

- Be careful not to get your finger caught in the disc tray when opening/closing it.

Operations during playback

Stop	[■]
Pause	[▶/] • Press again to resume.
Skip	[◀◀] [▶▶]
Search	[◀◀] [▶▶] • Searches only in the track.
View available information	[INFO] • Press repeatedly to switch the information.

Repeat playback

1 Press [NWP].

2 Press [↺].

“1↺”:

Only plays the selected track.

“↺”:

All tracks are repeated.

- Setting contents are stored even when the input source is switched.

Random playback

1 Press [NWP].

2 Press [RND].

- Press again to cancel.
- “RND” is displayed.
- Setting contents are stored even when the input source is switched.

Programme playback

1 Press [NWP].

2 Press [PGM] in the stop mode.

- “Program Mode” screen is displayed.

3 Press the numeric buttons to select tracks.

- Repeat this step to make further selections.

4 Press [▶/||] to start playback.

- “PGM” is displayed.

Stop	Press [■]. • Programmed contents are stored.
Check the programmed order	Press [◀] or [▶] in the stop mode.
Add tracks	Do step 3 in the stop mode.
Clear the last track	Press [CLEAR] in the stop mode. • You cannot select and clear a desired programmed track.

- Press [PGM] in the stop mode to cancel the programme mode, and the programme memory will be stored.
- To cancel the programme mode (The programme memory will be cleared.)
 - ① Press [■] in the stop mode.
 - ② Press [▲], [▼] to select “Yes” and then press [OK].

Note

- The programme memory will be cleared in the following conditions.
 - When this unit is turned off and on
 - When opening the disc tray
 - When switching the layer
- The programme mode is cancelled when the random playback is set.

Playing back Hybrid Super Audio CDs

Hybrid Super Audio CD discs include a conventional CD layer along with the Super Audio CD layer. Although Super Audio CD layer is preferentially played back, you can select the CD layer or Super Audio CD layer for playback by pressing [CD] while the playback stops.

Note

- Audio signal of Super Audio CD and Super Audio CD layer of Hybrid Super Audio CD cannot be output from the digital audio output terminal of this unit. Connect the device to the analogue audio output terminal.
- The layer cannot be selected on the disc except Hybrid Super Audio CD discs.
- “Super Audio CD” is displayed as an input source while Super Audio CD is played back.

Pure Disc Playback

By disabling the network functions, etc. this unit operates exclusively for the playback of CD/Super Audio CD for the higher quality sound.

- The factory default is “Off”.

1 Press [CD] for 5 seconds or longer.

- A confirmation screen appears.

2 Press [OK].

3 Press [▲], [▼] to select “Yes” and then press [OK].

- Playback of the online music streaming services, music files from network devices, etc. cannot be available while “Pure Disc Playback” is enabled.
- You can also set “Pure Disc Playback” to “On” from the setup menu.

① Press [NWP].

② Press [SETUP].

③ Press [▲], [▼] repeatedly to select “Pure Disc Playback” and then press [OK].

④ Press [▲], [▼] to select “On” and then press [OK].

Note

- This unit is not displayed as the output speakers on “Technics Audio Center” app, etc. after setting.
- Press [CD] again for 5 seconds or longer to cancel and return to the normal mode.
- Playback of the online music streaming services, music files from network devices, etc. cannot be available while “Pure Disc Playback” is enabled.
- The display is turned off by dimmer function after setting “Pure Disc Playback” to “On”. Press [DIMMER] repeatedly to switch the brightness. (⇒ 22)

Using USB device

You can connect a USB device to the unit and play back music stored on the USB device.

- Refer to “USB” (⇒ 123) for information about the USB device this unit can play back.

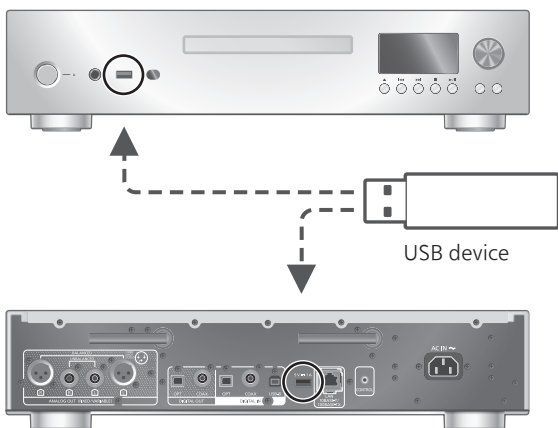

- 1 Connect a USB device to the USB-A terminal (USB-A Front/USB-A Rear) on the front/rear of this unit.**
- 2 Press [NWP].**
- 3 Press [>INPUT<] repeatedly to select “USB-A Front”/“USB-A Rear”.**
 - You can also select the input source by turning the multi control knob after pressing [INPUT] on the unit.
 - The folder/content selection screen will be displayed.
- 4 Press [▲], [▼] to select an item and then press [OK].**
 - Repeat this step to make further selections.
 - Press [RETURN] to return to the previous folder.

Using a USB HDD

When using a USB HDD with this unit, connect a USB HDD to the USB-A terminal (USB-A Rear) on the rear of this unit and switch the input source to “USB-A Rear”.

Note

- Do not connect a USB HDD to the USB-A terminal (USB-A Front) on the front of this unit.

Operations during playback

Stop	[■]
Pause	[▶/] • Press again to resume.
Skip	[⏮] [⏭]
Search	[⏪] [⏩]
View available information	[INFO] • Press repeatedly to switch the information.

- This operation may not be available for some formats.

Repeat playback

1 Press [NWP].

2 Press [↺].

“1↺”:

Only plays the selected track.

“↺”:

All tracks are repeated.

- Setting contents are stored even when the input source is switched.

Random playback

1 Press [NWP].

2 Press [RND].

- Press again to cancel.
- “RND” is displayed.
- During random playback, you may not skip to the previous track.
- During random playback, tracks may be played more than once.
- Setting contents are stored even when the input source is switched.

Add a track to playlist

You can add your favourite track to playlist.

- 1 Press [NWP].
- 2 Press [▲], [▼] to select a track to add.
- 3 Press [MENU].
- 4 Press [OK].

- “Added” is displayed after adding.
- You can add up to 1000 tracks to playlist.
- The playlist can be registered and set for each input source of “USB-A Front” and “USB-A Rear”.

Note

- The playlist cannot be played back properly with the other USB device except the registered one. When the content of USB device is changed or another USB device is connected, delete all tracks and add them again.
- The setting is deleted when AC mains lead is disconnected. It may also be deleted when this unit is turned off while “Standby Mode” is set to “Off”.

Calling up the playlist

- 1 Press [NWP].
- 2 Press [▲], [▼] to select “Playlist” and then press [OK].
- 3 Press [▲], [▼] to select a track and then press [OK].

Deleting the track from playlist

- 1 Press [NWP].
 - 2 Press [▲], [▼] to select "Playlist" and then press [OK].
 - 3 Press [▲], [▼] to select a track to delete.
 - 4 Press [MENU].
 - 5 Press [▲], [▼] to select "Delete One" and then press [OK].
 - 6 Press [▲], [▼] to select "Yes" and then press [OK].
- Select "Delete All" and press [OK] to delete all tracks from playlist.
 - "Deleted" is displayed after deleting.
 - "Empty" is displayed if no track is registered to the playlist.

Using digital audio output device

You can connect a digital audio output device with coaxial digital cable (not supplied) or optical digital audio cable (not supplied) to this unit and play back music.

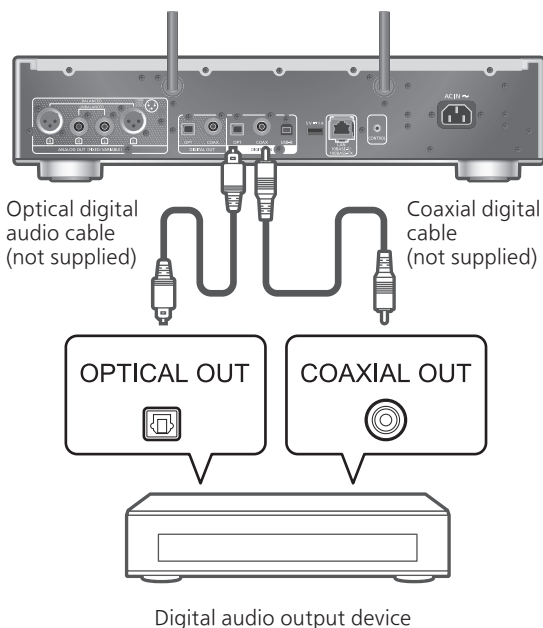

- 1 **Disconnect the AC mains lead.**
- 2 **Connect this unit and a digital audio output device.**
- 3 **Connect the AC mains lead to this unit.**
(⇒ 29)
- 4 **Press [NWP 
 - You can also select the input source by turning the multi control knob after pressing [INPUT] on the unit.**
- 6 **Start playback on the connected device.**

Note

- When enjoying video contents with this function, the video and audio output may not be synchronised.
- The digital audio input terminals of this unit can only detect the following linear PCM signals. For details, refer to the operating instructions of the connected device.
 - Sampling frequency:
 - Coaxial digital input
32/44.1/48/88.2/96/176.4/192 kHz
 - Optical digital input
32/44.1/48/88.2/96 kHz
 - Number of quantisation bits:
16/24 bit

Using PC, etc.

You can connect the PC, etc. or another device with USB 2.0 cable (not supplied) to this unit and play back music.

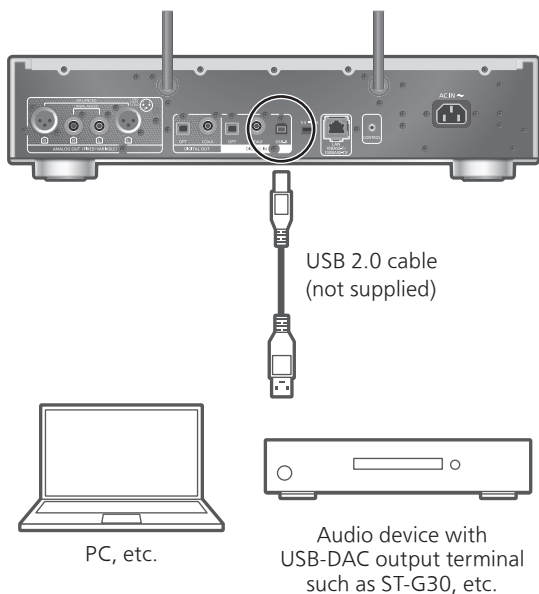

■ Preparation

Connecting to a PC

Before connecting to a PC, follow the steps below.



Refer to the following for the recommend OS versions for your PC (as of October, 2022):

Windows 8.1, Windows 10, Windows 11

macOS 10.12, 10.13, 10.14, 10.15, 11.0, 11.1, 11.2, 11.3, 11.4, 11.5, 12.1, 12.2, 12.3

- ① Download and install the dedicated USB driver to the PC. (Only for Windows OS)
 - Download and install the driver from the website below.
www.technics.com/support/
- ② Download and install the dedicated app "Technics Audio Player" (free of charge) on your PC.
 - Download and install the app from the website below.
www.technics.com/support/

Using USB 2.0 cable

- 1 Disconnect the AC mains lead.
- 2 Connect this unit and a PC, etc.
- 3 Connect the AC mains lead to this unit.
(⇒ 29)
- 4 Press [NWP ]/[CD ].
- 5 Press [>INPUT<] repeatedly to select "USB-B".
- 6 Start playback using the application on the connected PC.

Using Bluetooth®

You can listen to the sound from the Bluetooth® audio device from this unit wirelessly.

- Refer to the operating instructions of the Bluetooth® device for details.

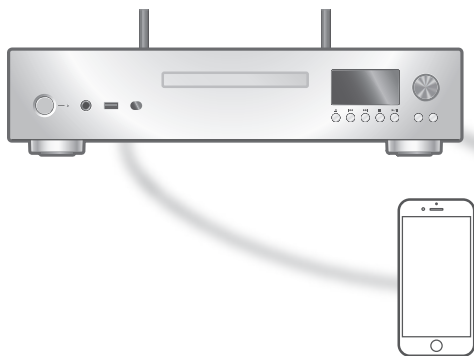

Bluetooth® device

Pairing a Bluetooth® device

■ Preparation

- Turn on the Bluetooth® device and place the device near this unit.
- Make sure that the Bluetooth® feature is activated on the device.
- If a Bluetooth® device is already connected, disconnect it. (⇒ 57)

■ Registering the Bluetooth® device

1 Press [NWP].

2 Press [>INPUT<] repeatedly to select "Bluetooth".

- You can also select the input source by turning the multi control knob after pressing [INPUT] on the unit.
- When "Pairing" is indicated on the display, proceed to step 6.

3 Press [MENU].

4 Press [▲], [▼] repeatedly to select "Pairing" and then press [OK].

5 Press [▲], [▼] to select "Yes" and then press [OK].

- "Pairing" is displayed, and this unit waits for registering.

6 Select “Technics-SL-G700M2-****” from the Bluetooth® device’s menu.

- The name of the connected device is indicated on the display.
- The MAC address “****” (“****” stands for a character that is unique to each set.) may be displayed before “Technics-SL-G700M2-****” is displayed.
- If the device name is set on the Google Home app or Apple Home app, the set name is displayed.

Note

- If prompted for the passkey, input “0000”.
- You can register up to 8 devices with this unit. If a 9th device is paired, the device that has not been used the longest may be replaced.
- While “Standby Mode” is set to “On” (⇒ 96), this unit automatically turns on when a Bluetooth® connection is established to this unit from a paired Bluetooth® device.

■ Listening to music stored on a Bluetooth® device

1 Press [NWP].

2 Press [>INPUT<] repeatedly to select “Bluetooth”.

- Set “Auto Reconnect” to “On” to connect the last connected Bluetooth® device automatically when “Bluetooth” is selected as an input source. (⇒ 58)
- “Ready” or “Pairing” is indicated on the display.

3 Select “Technics-SL-G700M2-****” from the Bluetooth® device’s menu.

- The name of the connected device is indicated on the display.
- If the device name is set on the Google Home app or Apple Home app, the set name is displayed.

4 Play music by operating the Bluetooth® device.

Note

- This unit can only be connected to one device at a time.

Operations during playback

Stop	[■]
Pause	[▶/] • Press again to resume.
Skip	[⏮] [⏭]

Note

- To use this unit's remote control/playback operation buttons with a Bluetooth® device, the Bluetooth® device must support AVRCP (Audio Video Remote Control Profile). Depending on the status of the device, some controls may not work.
- When enjoying video contents with this function, the video and audio output may not be synchronised.

Disconnecting a Bluetooth® device

- 1 Press [NWP].
- 2 Press [MENU].
- 3 Press [▲], [▼] repeatedly to select "Disconnect?" and then press [OK].
- 4 Press [▲], [▼] to select "Yes" and then press [OK].

Note

- The Bluetooth® device will be disconnected if a different audio source is selected.

Bluetooth® transmission mode

If a Bluetooth® device is already connected, disconnect it.

- 1 Press [NWP].
- 2 Press [MENU].
- 3 Press [▲], [▼] repeatedly to select “Link Mode” and then press [OK].
- 4 Press [▲], [▼] to select the mode and then press [OK].

Mode 1:

Emphasis on connectivity

Mode 2:

Emphasis on sound quality (default)

Note

- Select “Mode 1” if the sound is interrupted.

Automatically connects to the last connected Bluetooth® device “Auto Reconnect”

This unit connects to the last connected Bluetooth® device automatically when switching the input source to “Bluetooth”.

- The factory default is “On”.

- 1 Press [NWP].
- 2 Press [MENU].
- 3 Press [▲], [▼] repeatedly to select “Auto Reconnect” and then press [OK].
- 4 Press [▲], [▼] to select “On” / “Off” and then press [OK].

Note

- By selecting “Bluetooth” as an input source, this unit displays “Linking” and connects to the last connected Bluetooth® device automatically when “Auto Reconnect” is set to “On”.

Playing back music more natural-sounding audio "RE-MASTER"

Adjusts the playback band to achieve a higher bit depth to reproduce natural and expansive sounds close to original music sources.

- The factory default is "Off".

- 1 Press [NWP].
- 2 Press [MENU].
- 3 Press [▲], [▼] repeatedly to select "RE-MASTER" and then press [OK].
- 4 Press [▲], [▼] to select "On" / "Off" and then press [OK].

Playing back music files on the media server

You can share music files stored in the media server (PC, Network Attached Storage, etc.) connected to your home network, and enjoy the contents with this unit.

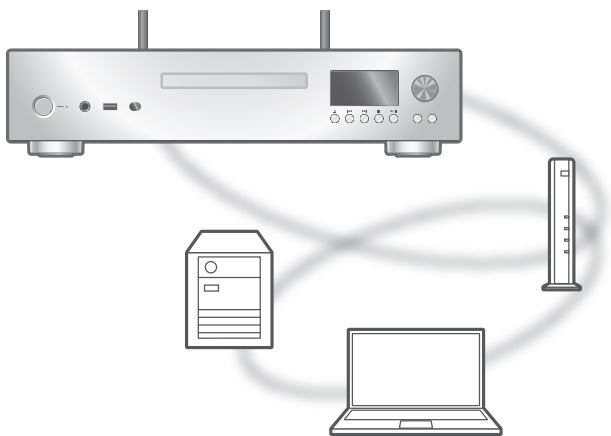

■ Preparation

- Complete the network settings. (⇒ 30)
- Connect the device to be used to the network of this unit.
- To use Windows Media® Player
 - Add the contents and folder to the libraries of the Windows Media® Player 11 or 12, or a smartphone, etc.
 - Playlist of Windows Media® Player can play back only the contents that are stored in the libraries.
 - To use Windows Media® Player for streaming, you need to configure it in advance.

Playing back content stored on the media server by controlling it from this unit

- 1 Press [NWP].
- 2 Press [>INPUT<] repeatedly to select "DMP".
 - You can also select the input source by turning the multi control knob after pressing [INPUT] on the unit.
 - The server selection screen will be displayed.
- 3 Press [▲], [▼] to select a media server on the network, and then press [OK].
 - The folder/content selection screen will be displayed. Repeat this step to make further selections.
 - Folders/content may be displayed in different order from the order on the server, depending on its specifications.
- 4 Press [▲], [▼] to select an item and then press [OK].

Note

- The connected server and its contents may not be displayed properly depending on its condition. (e.g. soon after adding the contents to the server, etc.)
Please try again later. For details, refer to the operating instructions of the device.
- The content may not be played back properly depending on the network condition.

Operations during playback

Stop	[■]
Pause	[▶/] • Press again to resume.
Skip	[⏮] [⏭]
Search	[⏪] [⏩]
View available information	[INFO] • Press repeatedly to switch the information.

Repeat playback

1 Press [NWP].

2 Press [↶].

“1↶”:

Only plays the selected track.

“↶”:

All tracks are repeated.

- Setting contents are stored even when the input source is switched.

Random playback

1 Press [NWP].

2 Press [RND].

- Press again to cancel.
- “RND” is displayed.
- During random playback, you may not skip to the previous track.
- During random playback, tracks may be played more than once.
- Setting contents are stored even when the input source is switched.

Operations using the dedicated app

“Technics Audio Center”

If you install the dedicated app “Technics Audio Center” (free of charge) on your tablet/smartphone, you can control this unit using a wide variety of functions.

For details, visit:

www.technics.com/support/

Playing back content stored on the media server by controlling it from a DMC

By controlling a DMC (Digital Media Controller) compatible device, you can play back music stored on the media server on this unit (DMR—Digital Media Renderer).

Operate the DMC compatible device and connect to this unit.

- The device name of this unit will be displayed as "Technics-SL-G700M2-****"*^{1, 2}.
- For details on how to use DMC compatible devices, refer to the operating instructions of the devices or the software.

Note

- When you operate the media server, playback of other audio sources will stop and media server output will have priority.
 - Depending on the contents and the connected equipment, operations or playback may not be possible.
 - This unit does not guarantee connection with all DMC applications. Use the dedicated app "Technics Audio Center".
- *1: "****" stands for a digit that is unique to each set.
- *2: The device name can be changed from "This unit's name on the network". (⇒ 39)

Playing Internet Radio and Podcasts

This unit supports an audio broadcasting service transmitted via the Internet, and Internet Radio and Podcasts can be played back.

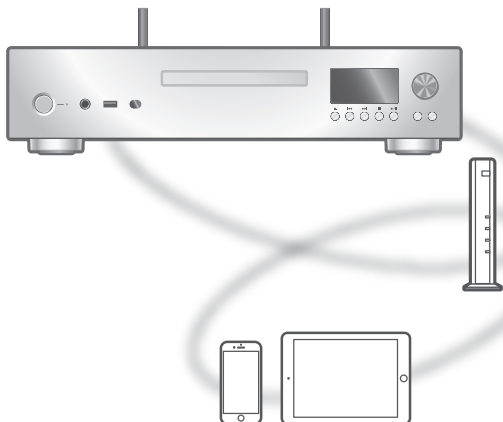

■ Preparation

- Complete the network settings. (⇒ 30)
 - Make sure that the network is connected to the Internet.

1 Press [NWP].

2 Press [>INPUT<] repeatedly to select “Internet Radio” / “Podcasts”.

- You can also select the input source by turning the multi control knob after pressing [INPUT] on the unit.
- When “Internet Radio” / “Podcasts” is selected as the source, this unit will automatically try and connect to the last selected station.

3 Press [▲], [▼] to select a station and then press [OK].

- Repeat this step to make further selections according to the genre, region, etc.
- The station that does not broadcast cannot be played back. (It will be skipped or return to the list.)

Note

- Internet Radio and Podcasts may be suspended or be otherwise unavailable without notice.
- Internet Radio may not be played back properly depending on the network condition.

Operations during playback

Stop	[■] (Returns to the list.)
Pause (Podcasts)	[▶/] • Press again to resume.
Skip	[⏮] [⏭]
Search (Podcasts)	[⏪] [⏩]

Repeat playback

1 Press [NWP].

2 Press [↺].

“1↺”:

Only plays the selected track.

“↺”:

All tracks are repeated.

- Setting contents are stored even when the input source is switched.
- Repeat playback is not available for the content of “Internet Radio”.

Random playback

1 Press [NWP].

2 Press [RND].

- Press again to cancel.
- “RND” is displayed.
- During random playback, you may not skip to the previous track.
- During random playback, tracks may be played more than once.
- Setting contents are stored even when the input source is switched.
- Random playback is not available for the content of “Internet Radio”.

Adding a station to favourite list "Add Favourites"

- 1 Press [NWP].
 - 2 Press [▲], [▼] to select a station and then press [OK].
 - 3 Press [MENU].
 - 4 Select "Add Favourites" and then press [OK].
- "Added" is displayed after registering.

Call up the favourite track/album/ artist

- 1 Press [NWP].
- 2 Press [▲], [▼] repeatedly to select "Favorites" and then press [OK].
 - "Favorites" is displayed on the first layer. Press [RETURN] to return to the previous folder.
- 3 Press [▲], [▼] to select the content and then press [OK].
 - "Empty" is displayed if no station is registered to the favourite list.

Deleting the favourite station "Delete Favourites"

- 1 Press [NWP].
 - 2 Press [▲], [▼] to select a station to delete from the favourite list.
 - 3 Press [MENU].
 - 4 Select "Delete Favourites" and then press [OK].
 - 5 Press [▲], [▼] to select "Yes" and then press [OK].
- "Deleted" is displayed after deleting.

Operations using the dedicated app “Technics Audio Center”

If you install the dedicated app “Technics Audio Center” (free of charge) on your tablet/smartphone, you can control this unit using a wide variety of functions.

For details, visit:

www.technics.com/support/

Playing audio using Spotify Connect

This unit is compatible with Spotify Connect for the online music service (Spotify).

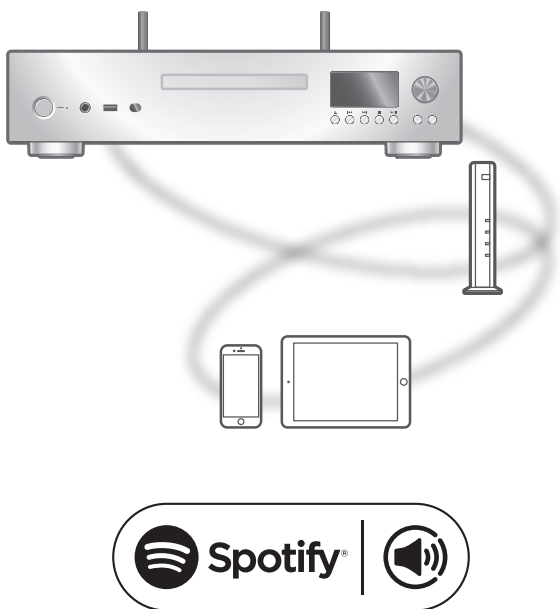

■ Preparation

- Complete the network settings. (⇒ 30)
 - Make sure that the network is connected to the Internet.
- Connect the device to be used to the network of this unit.

Use your phone, tablet or computer as a remote control for Spotify.

Go to spotify.com/connect to learn how

Note

- The device name of this unit will be displayed as "Technics-SL-G700M2-****"*^{1, 2}.
 - If the device name is set on the Google Home app or Apple Home app, the set name is displayed.
 - Registration/subscription is required.
 - Spotify Premium requires a usage charge.
 - Services, icons, and specifications are subject to change.
- *1: "****" stands for a number that is unique to each set.
- *2: The device name can be changed from "This unit's name on the network". (⇒ 39)

Using TIDAL

You can play music from the music streaming service, TIDAL on this unit with the dedicated application “Technics Audio Center” (free of charge) on your smartphone, tablet, etc.

For details of TIDAL, visit the following website.

www.tidal.com

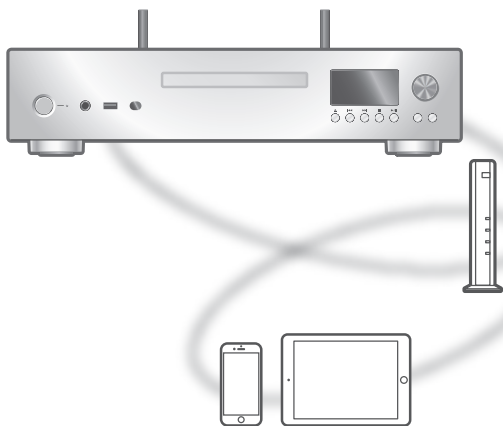

■ Preparation

- Install the latest “Technics Audio Center” on your device (smartphone, tablet, etc.).
For details, visit:
www.technics.com/support/
- Connect this unit and your device on which “Technics Audio Center” has been installed to the network connected to the internet. For details, refer to their operating instructions.
- When TIDAL is used for the first time, log into TIDAL. Perform the following steps for login.
 - ① Start “Technics Audio Center” on your device (smartphone, tablet, etc.).
 - ② Select “TIDAL” from “Technics Audio Center”.
 - ③ Log into TIDAL. (If you do not have an account, you need to register the account.)

1 Press [NWP].

2 Press [>INPUT<] repeatedly to select "TIDAL".

- You can also select the input source by turning the multi control knob after pressing [INPUT] on the unit.
- When TIDAL is used for the first time, "Operate via App" is displayed. Use the dedicated app "Technics Audio Center" for operating.
- The playback operation screen is displayed when you have played back TIDAL before.

3 Press [▲], [▼] to select an item and then press [OK].

- Repeat this step to make further selections.
- Press [RETURN] to return to the previous folder.
- Folders/content may be displayed in different order from the order on the connected device, depending on its specifications.

Note

- Depending on the country or region, playback may not be available.

Operations during playback

Stop	[■] (Returns to the list.)
Pause	[▶/] • Press again to resume.
Skip	[◀◀] [▶▶]
Search	[◀◀] [▶▶]

Repeat playback

1 Press [NWP].

2 Press [↺].

"1↺":

Only plays the selected track.

"↺":

All tracks are repeated.

- Setting contents are stored even when the input source is switched.

Random playback

1 Press [NWP].

2 Press [RND].

- Press again to cancel.
- "RND" is displayed.
- During random playback, you may not skip to the previous track.
- Setting contents are stored even when the input source is switched.

Adding a track/album/artist, etc. to favourite list "Add Favourites"

1 Press [NWP].

2 Press [▲], [▼] to select a content to add and then press [OK].

- Repeat this step to make further selections.
- Press [RETURN] to return to the previous folder.
- Folders/content may be displayed in different order from the order on the connected device, depending on its specifications.

3 Press [MENU].

4 Select "Add Favourites" and then press [OK].

- "Added" is displayed after registering.

Call up the favourite track/album/ artist

1 Press [NWP].

2 Press [▲], [▼] repeatedly to select "My Music" and then press [OK].

- "My Music" is displayed on the first layer. Press [RETURN] to return to the previous folder.

3 Press [▲], [▼] to select the content and then press [OK].

- "Empty" is displayed if no station is registered to the favourite list.

Deleting the track/album/artist “Delete Favourites”

- 1 Press [NWP]
- 2 Press [▲], [▼] to select a content to delete from the favourite list.
- 3 Press [MENU].
- 4 Select “Delete Favourites” and then press [OK].
- 5 Press [▲], [▼] to select “Yes” and then press [OK].
 - “Deleted” is displayed after deleting.

Operations using the dedicated app “Technics Audio Center”

You start the playback using “Technics Audio Center” on your tablet/smartphone.

- If you select TIDAL from “Technics Audio Center” on your tablet/smartphone, the input is automatically switched to TIDAL.
- For details, visit:
www.technics.com/support/

Using Deezer

You can play music from the music streaming service, Deezer on this unit with the dedicated application “Technics Audio Center” (free of charge) on your smartphone, tablet, etc.

For details of Deezer, visit the following website.

www.deezer.com

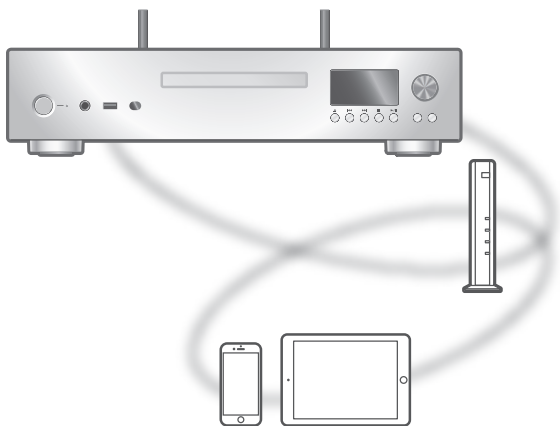

■ Preparation

- Install the latest “Technics Audio Center” on your device (smartphone, tablet, etc.).
For details, visit:
www.technics.com/support/
- Connect this unit and your device on which “Technics Audio Center” has been installed to the network connected to the internet. For details, refer to their operating instructions.
- When Deezer is used for the first time, log into Deezer. Perform the following steps for login.
 - ① Start “Technics Audio Center” on your device (smartphone, tablet, etc.).
 - ② Select “Deezer” from “Technics Audio Center”.
 - ③ Log into Deezer. (If you do not have an account, you need to register the account.)

1 Press [NWP].

2 Press [>INPUT<] repeatedly to select “Deezer”.

- You can also select the input source by turning the multi control knob after pressing [INPUT] on the unit.
- When Deezer is used for the first time, “Operate via App” is displayed. Use the dedicated app “Technics Audio Center” for operating.
- The playback operation screen is displayed when you have played back Deezer before.

3 Press [▲], [▼] to select an item and then press [OK].

- Repeat this step to make further selections.
- Press [RETURN] to return to the previous folder.
- Folders/content may be displayed in different order from the order on the connected device, depending on its specifications.

Note

- Depending on the country or region, playback may not be available.

Operations during playback

Stop	[■] (Returns to the list.)
Pause	[▶/] • Press again to resume.
Skip	[⏮] [⏭]
Search	[⏪] [⏩]

Repeat playback

1 Press [NWP].

2 Press [↺].

“1↺”:

Only plays the selected track.

“↺”:

All tracks are repeated.

- Setting contents are stored even when the input source is switched.

Random playback

1 Press [NWP].

2 Press [RND].

- Press again to cancel.
- "RND" is displayed.
- During random playback, you may not skip to the previous track.
- Setting contents are stored even when the input source is switched.

Adding a track/album/artist, etc. to favourite list "Add Favourites"

1 Press [NWP].

2 Press [▲], [▼] to select a content to add and then press [OK].

- Repeat this step to make further selections.
- Press [RETURN] to return to the previous folder.
- Folders/content may be displayed in different order from the order on the connected device, depending on its specifications.

3 Press [MENU].

4 Select "Add Favourites" and then press [OK].

- "Added" is displayed after registering.

Call up the favourite track/album/ artist

1 Press [NWP].

2 Press [▲], [▼] repeatedly to select "My library" and then press [OK].

- "My library" is displayed on the first layer. Press [RETURN] to return to the previous folder.

3 Press [▲], [▼] to select the content and then press [OK].

- "Empty" is displayed if no station is registered to the favourite list.

Deleting the track/album/artist “Delete Favourites”

- 1 Press [NWP].
- 2 Press [▲], [▼] to select a content to delete from the favourite list.
- 3 Press [MENU].
- 4 Select “Delete Favourites” and then press [OK].
- 5 Press [▲], [▼] to select “Yes” and then press [OK].
 - “Deleted” is displayed after deleting.

Operations using the dedicated app “Technics Audio Center”

You start the playback using “Technics Audio Center” on your tablet/smartphone.

- If you select Deezer from “Technics Audio Center” on your tablet/smartphone, the input is automatically switched to Deezer.
- For details, visit:
www.technics.com/support/

Using Amazon Music

You can play music from the music streaming service, Amazon Music on this unit with the dedicated application “Technics Music App” (free of charge) on your smartphone, tablet, etc.

For details of Amazon Music, visit the following website.

www.amazonmusic.com

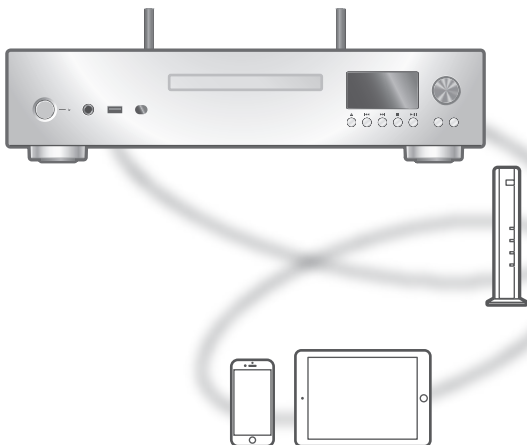

amazon music

■ Preparation

- Install the latest “Technics Music App” on your device (smartphone, tablet, etc.).

For details, visit:

www.technics.com/support/

- Connect this unit and your device on which “Technics Music App” has been installed to the network connected to the internet. For details, refer to their operating instructions.
- When Amazon Music is used for the first time, log into Amazon Music. Perform the following steps for login.
 - ① Start “Technics Music App” on your device (smartphone, tablet, etc.).
 - ② Select “Amazon Music” from “Technics Music App”.
 - ③ Log into Amazon Music. (If you do not have an account, you need to register the account.)

1 Press [NWP].

2 Press [>INPUT<] repeatedly to select “Amazon Music”.

- You can also select the input source by turning the multi control knob after pressing [INPUT] on the unit.
- When Amazon Music is used for the first time, “Operate via App” is displayed. Use the dedicated app “Technics Audio Center” for operating.
- The playback operation screen is displayed when you have played back Amazon Music before.

3 Press [▲], [▼] to select an item and then press [OK].

- Repeat this step to make further selections.
- Press [RETURN] to return to the previous folder.
- Folders/content may be displayed in different order from the order on the connected device, depending on its specifications.

Note

- Some operations may not be available depending on the music streaming service.

Operations during playback

Stop	[■] (Returns to the list.)
Pause	[▶/] • Press again to resume.
Skip	[◀◀] [▶▶]
Search	[◀◀] [▶▶]

Repeat playback

1 Press [NWP].

2 Press [↻].

“1↻”:

Only plays the selected track.

“↻”:

All tracks are repeated.

- Setting contents are stored even when the input source is switched.

Random playback

1 Press [NWP].

2 Press [RND].

- Press again to cancel.
- "RND" is displayed.
- During random playback, you may not skip to the previous track.
- Setting contents are stored even when the input source is switched.

Operations using the dedicated app "Technics Audio Center"

You start the playback using "Technics Audio Center" on your tablet/smartphone.

- If you select Amazon Music from "Technics Audio Center" on your tablet/smartphone, the input is automatically switched to Amazon Music.
- For details, visit:
www.technics.com/support/

Using Qobuz

You can play music from the music streaming service, Qobuz on this unit with the dedicated application “Technics Audio Center” (free of charge) on your smartphone, tablet, etc.

For details of Qobuz, visit the following website.

www.qobuz.com

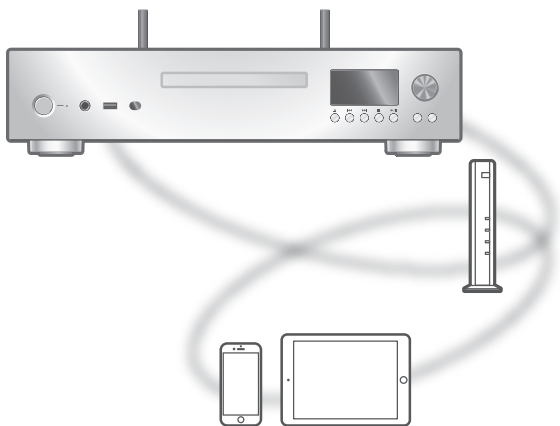

■ Preparation

- Install the latest “Technics Audio Center” on your device (smartphone, tablet, etc.).
For details, visit:
www.technics.com/support/
- Connect this unit and your device on which “Technics Audio Center” has been installed to the network connected to the internet. For details, refer to their operating instructions.
- When Qobuz is used for the first time, log into Qobuz. Perform the following steps for login.
 - ① Start “Technics Audio Center” on your device (smartphone, tablet, etc.).
 - ② Select “Qobuz” from “Technics Audio Center”.
 - ③ Log into Qobuz. (If you do not have an account, you need to register the account.)

1 Press [NWP].

2 Press [>INPUT<] repeatedly to select “Qobuz”.

- You can also select the input source by turning the multi control knob after pressing [INPUT] on the unit.
- When Qobuz is used for the first time, “Operate via App” is displayed. Use the dedicated app “Technics Audio Center” for operating.
- The playback operation screen is displayed when you have played back Qobuz before.

3 Press [▲], [▼] to select an item and then press [OK].

- Repeat this step to make further selections.
- Press [RETURN] to return to the previous folder.
- Folders/content may be displayed in different order from the order on the connected device, depending on its specifications.

Note

- Depending on the country or region, playback may not be available.

Operations during playback

Stop	[■] (Returns to the list.)
Pause	[▶/] • Press again to resume.
Skip	[◀◀] [▶▶]
Search	[◀◀] [▶▶]

Repeat playback

1 Press [NWP].

2 Press [↺].

“1↺”:

Only plays the selected track.

“↺”:

All tracks are repeated.

- Setting contents are stored even when the input source is switched.

Random playback

1 Press [NWP].

2 Press [RND].

- Press again to cancel.
- "RND" is displayed.
- During random playback, you may not skip to the previous track.
- Setting contents are stored even when the input source is switched.

Adding a track/album/artist, etc. to favourite list "Add Favourites"

1 Press [NWP].

2 Press [▲], [▼] to select a content to add and then press [OK].

- Repeat this step to make further selections.
- Press [RETURN] to return to the previous folder.
- Folders/content may be displayed in different order from the order on the connected device, depending on its specifications.

3 Press [MENU].

4 Select "Add Favourites" and then press [OK].

- "Added" is displayed after registering.

Call up the favourite track/album/ artist

1 Press [NWP].

2 Press [▲], [▼] repeatedly to select "Favorites" and then press [OK].

- "Favorites" is displayed on the first layer. Press [RETURN] to return to the previous folder.
- Select "Playlists" to call up the favourite playlist.

3 Press [▲], [▼] to select the content and then press [OK].

- "Empty" is displayed if no station is registered to the favourite list.

Deleting the track/album/artist “Delete Favourites”

- 1 Press [NWP].
- 2 Press [▲], [▼] to select a content to delete from the favourite list.
- 3 Press [MENU].
- 4 Select “Delete Favourites” and then press [OK].
- 5 Press [▲], [▼] to select “Yes” and then press [OK].
 - “Deleted” is displayed after deleting.

Operations using the dedicated app “Technics Audio Center”

You start the playback using “Technics Audio Center” on your tablet/smartphone.

- If you select Qobuz from “Technics Audio Center” on your tablet/smartphone, the input is automatically switched to Qobuz.
- For details, visit:
www.technics.com/support/

Listening to music using Chromecast-enabled app

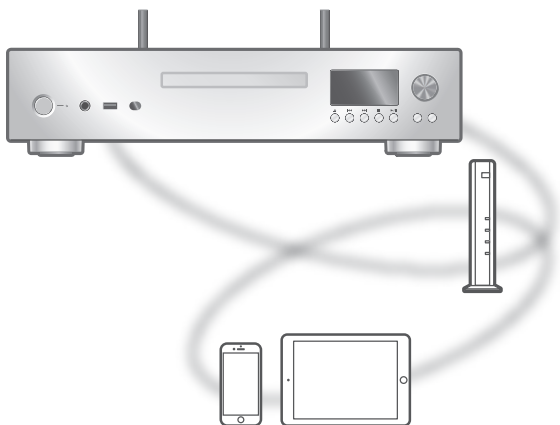

This unit is compatible with Chromecast-enabled apps. For detailed information of Chromecast-enabled apps, visit: g.co/cast/apps

■ Preparation

- Complete the network settings. (⇒ 30)
 - Make sure that the network is connected to the Internet.
- Install a Chromecast-enabled app on your device (smartphone, tablet, etc.).
- Connect the device to the network currently used at home.

1 Start the Chromecast-enabled app on your device (smartphone, tablet, etc.) and select this unit as the connecting device.

- The input source is automatically switched to “Casting”.

2 Play back the music.

Using AirPlay

You can play back music stored on iOS device, etc. using AirPlay.

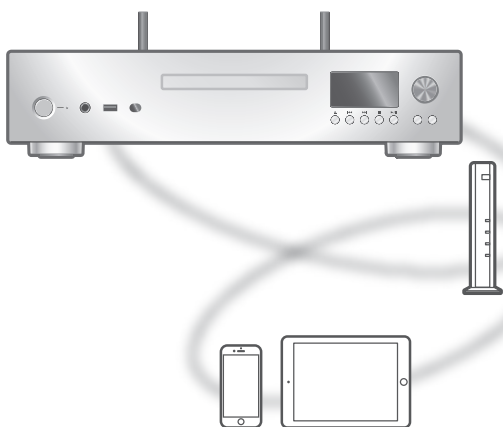

■ Preparation

- Complete the network settings. (⇒ 30)
- Connect the iOS device or PC to the same network as this unit.

1 (iOS device)

Start the “Music” (or iPod) app.

(PC)

Start “iTunes”.

2 Select “Technics-SL-G700M2-****”^{*1, 2} from the AirPlay icon (e.g.).

- If the device name is set on the Google Home app or Apple Home app, the set name is displayed.

3 Start play.

- Check the volume settings before starting the playback.
- When AirPlay is used for the first time, the volume may be output at the maximum setting.
- The playback will start with a slight delay.

*1: “****” stands for a number that is unique to each set.

*2: The device name can be changed from “This unit’s name on the network”. (⇒ 39)

Operations during playback

Pause	[■] [▶/] • Press [▶/] again to resume.
Skip	[◀◀] [▶▶]
View available information	[INFO] • Press repeatedly to switch the information.

- You can also operate on the connected iOS device/PC.

Note

- Volume changes on the iOS device or iTunes will apply to this unit. (Refer to the iTunes Help for the required settings in iTunes.)
- Playback of other audio sources will stop and AirPlay output will have priority.
- With some iOS and iTunes versions, it may not be possible to restart the AirPlay playback if the selector is changed or the unit is turned to standby mode, during the AirPlay playback. In this case, select a different device from the AirPlay icon of the Music app or iTunes and then re-select this unit as the output speakers.
- AirPlay will not work when playing back videos on iTunes.

Settings

Sound adjustment	90
Adjusting the volume of headphones "PHONES VOL"	90
Playing back CD/Super Audio CD for the higher quality sound "Pure Disc Playback"	90
MQA decoding "MQA Decoding"	91
Enabling the native playback for DSD signal "DSD Native"	91
Disabling audio output "Digital Output"/"Analog Output"	91
Setting the sampling frequency "D.Output fs"	91
Setting the analogue audio output "A.Output Level"	92
Adjusts the phase and amplitude shift of analogue audio output "Coherent Processing"	92
Adjusts the sound quality of analogue audio output "Filter"	93
Setting the limitation of headphones output "PHONES VOL Limitation"	93
Other settings	94
Sleep timer "SLEEP"	94
Auto off function "Auto Off"	95
Auto dimming function "Auto DIMMER"	95
Sets dimming function steps "DIMMER Steps"	95
Network standby "Standby Mode"	96
Network settings "Network"	96

Changing the character encoding "E Asian Character"	96
Checking the model name "Model No."	97
Checking the firmware version "F/W Version"	97
Firmware updates "F/W Update"	97
Decoding MQA source	100
Recommended setting for each output and function of the connected device	101
Using the favourite function (FAV)	103
Registering your favourite station, music or playlist.....	103
Calling up the favourite station, music or playlist.....	103
Deleting the favourite station, music or playlist.....	104
Operations using the dedicated app "Technics Audio Center"	104
System control connection.....	105
Using system connection cable and audio cable	106
Switching this unit and the connected device to on/standby simultaneously.....	106
Switching function for the input source of the connected device "Selector Link Type"	107
Adjusting BASS/MID/TREBLE "Tone Control"	107

 Table of contents ... 05



- 1 Press [NWP].
 - 2 Press [SETUP].
 - 3 Press [▲], [▼] repeatedly to select the menu and then press [OK].
 - 4 Press [▲], [▼], [◀], [▶] to set, and press [OK].
- You can also enter a setup screen by pressing and holding multi control knob on the unit. (Use the remote control for setting some items.)

Adjusting the volume of headphones "PHONES VOL"

You can adjust the volume of headphones. (⇒ 19)

- -- dB (min), -99.0 dB to 0 dB (max)
- The factory default is "-60.0 dB".

Playing back CD/Super Audio CD for the higher quality sound "Pure Disc Playback"

By disabling the network functions, etc. this unit operates exclusively for the playback of CD/Super Audio CD for the higher quality sound. (⇒ 46)

- The factory default is "Off".

MQA decoding "MQA Decoding"

An MQA file or stream needs to be decoded to deliver the master quality audio. Switch the MQA decoding function to "On" or "Off". (⇒ 100)

- The factory default is "On".

Enabling the native playback for DSD signal "DSD Native"

Enabling the native playback for DSD signal from the USB device or network device (DMP/DMR).

- The factory default is "Off".
- DSD signal which is input to this unit from USB device or network device (DMP/DMR) is converted to linear PCM signal (up to 192 kHz).
- The setting can be changed while playing back the USB device or network device but playback may stop.
- Set to "Off" when the content is not played back properly.

Disabling audio output "Digital Output"/"Analog Output"

Disabling the audio output of unused terminals minimises noise and allows playback in higher audio quality.

- The factory default is "On".
- Set "Digital Output" to "Off" to disable the digital audio output.
- Set "Analog Output" to "Off" to disable the analogue audio output.

Setting the sampling frequency "D.Output fs"

You can set an upper limit on the output sampling frequency range. Please note that the range that can be processed differs depending on the amplifier with digital input terminal. For details, refer to the operating instructions of the connected device.

- The factory default is "32kHz-192kHz".
- Set "Digital Output" to "On" to use this function.
- 96 kHz or 192 kHz can be set as the upper limit on the output sampling frequency range.

Setting the analogue audio output “A.Output Level”

You can set the analogue audio output level is fixed or adjustable when changing the volume with this unit. (⇒ 27)

- The factory default is “Fixed”.
- When you connect a power amplifier, etc., set “A.Output Level” to “Variable” for volume control with this unit. When you connect a pre-amplifier, etc., set “A.Output Level” to “Fixed” for volume control with the connected device.
- The factory default of the analogue audio output level is “-60.0 dB” when setting to “Variable”.
- -- dB (min), -99.0 dB to 0 dB (max)
- Set “Analog Output” to “On” to use this function.

Adjusts the phase and amplitude shift of analogue audio output “Coherent Processing”

Adjusts the phase and amplitude shift when converting digital signal to analogue audio output signal.

- The factory default is “On”.
- Set “Analog Output” to “On” to use this function.
- This function is available for audio signal of 192 kHz or less.
- This function is not available for DSD signal*1 including Super Audio CD or while the headphones are connected.

*1: DSD signal is available which is input to this unit from USB device or network device (DMP/DMR) only when “DSD Native” is set to “Off”.

Adjusts the sound quality of analogue audio output “Filter”

You can adjust the sound quality of an analogue audio output. Stop the playback before setting and select the mode as your favourite with listening to the actual sound. Filter name for each mode is as below.

Mode 1:

Slow Roll-off (minimum phase)

Mode 2:

Slow Roll-off (linear phase)

Mode 3:

Fast Roll-off (minimum phase)

- The factory default is “Mode 1”.
- Set “Analog Output” to “On” to use this function.

Note

- The specific filtering setting is given priority and this setting cannot be changed in the following conditions.
 - While playing back DSD signal*1 including Super Audio CD
 - “MQA Decoding” is set to “On”.
 - “Coherent Processing” is set to “On”.

*1: The setting can be changed and the setting filter is available for DSD signal which is input to this unit from USB device or network device (DMP/DMR) only when “DSD Native” is set to “Off”.

Setting the limitation of headphones output “PHONES VOL Limitation”

You can set an upper limit on the headphones output to avoid the extremely high volume when turning this unit or playing back.

- The factory default is “On”.



- 1 Press [NWP].
 - 2 Press [SETUP].
 - 3 Press [▲], [▼] repeatedly to select the menu and then press [OK].
 - 4 Press [▲], [▼], [◀], [▶] to set, and press [OK].
- You can also enter a setup screen by pressing and holding multi control knob on the unit. (Use the remote control for setting some items.)

Sleep timer "SLEEP"

The sleep timer can turn the unit to standby mode after a set time. (30 minutes/60 minutes/90 minutes/120 minutes/Off)

- "SLEEP" is displayed after setting.
- The sleep timer will be cleared in the following conditions.
 - When setting "Initialization"
 - When setting up the wireless LAN function
 - When updating firmware

Auto off function

“Auto Off”

While the setting is set to “On”, this unit automatically enters standby mode for saving energy, if no sound output without operation such as pressing buttons, etc. for approx. 20 minutes.

- The factory default is “On”. To disable this function, select “Off”.

Note

- The setting is stored even if the power is turned off and on.
- “Auto Off” is displayed 3 minutes before this unit is turned off.

Auto dimming function

“Auto DIMMER”

While the setting is set to “On”, this unit temporarily adjust the brightness of the display, power indicator, etc., if no sound output without operation such as pressing buttons, etc. for approx. 20 minutes.

- The factory default is “On”.
- “Auto Off” has priority over auto dimming and this unit turns off automatically when “Auto Off” is set to “On”.

Sets dimming function steps

“DIMMER Steps”

You can turn off the power indicator in addition to adjusting the brightness of this unit as 4 steps by pressing [DIMMER] when “DIMMER Steps” is set to “5 (including Blackout)”.

- The factory default is “4”.
- This unit is not turned off even when the brightness is turned off.
- When the brightness is turned off, the power indicator (red) is also turned off in standby mode.
- When [DIMMER] works for the connected Technics devices, dimming step may not match between this unit and the connected devices. Set to “4” or adjust the steps for each.

Network standby "Standby Mode"

When this function is set to "On", then this unit automatically turns on in the following cases.

- When a Bluetooth® connection is established to this unit from a paired Bluetooth® device.
- When playback operations are performed on this unit from a device connected to the network.
- The factory default is "On". To disable this function, select "Off".

Network settings "Network"

Wi-Fi setting "Wi-Fi Menu"

The wireless LAN function can be enabled or disabled.

- The factory default is "On".

Displaying the network icon "Network Indicator"

Set to "Off" to turn the network icon (Wired LAN / Wireless LAN) off from the display.

- The factory default is "On".

Wi-Fi signal strength "Signal Level"

To check the Wi-Fi signal strength where this system is located.

- The signal strength is shown as 3 (max) - 2 - 1. If the indicator shows "2" or "1", change the position or angle of your wireless router or this system, and see if the connection improves.
- If "0" is displayed, this system cannot establish a link with the wireless router.

Changing the character encoding "E Asian Character"

You can change the character encoding of track names, artist names and other information when they are not displayed as they should be.

Type 1(日本):

Priority is given to Japanese. (default)

Type 2(简体字):

Priority is given to Chinese (Simplified).

Checking the model name

“Model No.”

The model name is displayed.

Checking the firmware version

“F/W Version”

The version of the installed firmware is displayed.

Firmware updates

“F/W Update”

Occasionally, Panasonic may release updated firmware for this unit that may add or improve the way a feature operates. These updates are available free of charge.

- For the update information, refer to the following website.

www.technics.com/support/firmware/

**Downloading takes approx. 15 minutes.
Do not disconnect the AC mains lead or turn this unit to standby while updating.
Do not disconnect the USB flash memory while updating.**

- The progress is displayed as “Updating □ %” while updating. (“□” stands for a number.)

Note

- During the update process, no other operations can be performed.
- If there are no updates, “Firmware is Up To Date” is displayed. (No need to update it.)
- Updating the firmware may reset the settings of this unit.

Update via Internet

■ Preparation

- Connect this unit to the network. (⇒ 30)
 - Make sure that the network is connected to the Internet.

1 Press [NWP].

2 Press [SETUP].

3 Press [▲], [▼] repeatedly to select “F/W Update” and then press [OK].

4 Press [▲], [▼] to select “Internet” and then press [OK].

5 Press [▲], [▼] to select “Yes” and then press [OK].

- The progress is displayed as “Updating □ %” while updating. (“□” stands for a number.)
- When the update has finished successfully, “Success” is displayed.

6 Press [⏻/|] on the unit to turn this unit off and on.

Note

- Downloading may take longer depending on the internet connection environment, etc.
- Firmware updating may automatically start after the network setting is complete (⇒ 30).

Update via USB flash memory

■ Preparation

- Download the latest firmware on the USB flash memory. For details, refer to the following website.

www.technics.com/support/firmware/

1 Connect the USB flash memory with new firmware to the USB-A terminal (USB-A Front) on the front of this unit.

- The USB-A terminal (USB-A Rear) on the rear of this unit is not available for firmware updating by USB flash memory.

2 Press [NWP].

3 Press [SETUP].

4 Press [▲], [▼] repeatedly to select “F/W Update” and then press [OK].

5 Press [▲], [▼] to select “USB-A Front” and then press [OK].

6 Press [▲], [▼] to select “Yes” and then press [OK].

- The progress is displayed as “Updating □ %” while updating. (“□” stands for a number.)
- When the update has finished successfully, “Success” is displayed.

7 Press [⏻/|] on the unit to turn this unit off and on.

Note

- Downloading may take longer depending on the USB flash memory.

Decoding MQA source

This unit includes the MQA (Master Quality Authenticated) technology, which enables playback of MQA audio files and streams, delivering the sound of the original master recording. This unit is a CD player that can recognise an MQA-CD. The built-in MQA decoder will restore the high-resolution signal heard in the studio and confirm it, using the authentication signature.

To deliver the master quality audio of MQA, MQA decoding function needs to be set to "On". Switch the MQA decoding function to "On" or "Off" in the following steps.

- The factory default is "On".
- "MQA" is displayed while MQA content is played back. Audio setting status such as MQA decoding status, etc. is displayed by pressing [INFO] while playing back MQA audio file.

1 Press [NWP].

2 Press [MQA] to switch the MQA decoding function to "On".

- "MQA Decoding : On" is displayed.

3 Play back the MQA file.

- "MQA" is displayed.

- When only using the analogue audio, set "Digital Output" to "Off" for better sound quality of MQA content playback.
- You can also set "MQA Decoding" to "On" from the setup menu.
 - ① Press [NWP].
 - ② Press [SETUP].
 - ③ Press [▲], [▼] repeatedly to select "MQA Decoding" and then press [OK].
 - ④ Press [▲], [▼] to select "On" and then press [OK].
- When only using the analogue audio, set "Digital Output" to "Off" for better sound quality of MQA content playback.

Note

- “MQA” or “MQA Studio” indicates that the unit is decoding and playing an MQA stream or file, and denotes provenance to ensure that the sound is identical to that of the source material. “MQA Studio” indicates it is playing an MQA Studio file, which has either been approved in the studio by the artist/producer or has been verified by the copyright owner.
“OFS” is displayed for MQA rendering function.
For details, visit:
<https://www.mqa.co.uk/>
- MQA files or streams may not be decoded to deliver the master quality audio depending on the setting of the connected digital audio device. For details, refer to the operating instructions of the connected device. For information of Technics devices, refer to the following website.
www.technics.com/support/
- When MQA audio file cannot be played back properly, set “DSD Native” to “Off”. The performance may be improved. (⇒ 91)
- Specifications are subject to change without notice.

Recommended setting for each output and function of the connected device

■ MQA Core Decoder

Digital output (COAX/OPT)	“Digital Output” is set to “On”. “MQA Decoding” is set to “Off”.
Analogue output (BALANCED/ UNBALANCED)	“Digital Output” is set to “Off”. “MQA Decoding” is set to “On”.

■ MQA Renderer

Digital output (COAX/OPT)	“Digital Output” is set to “On”. “MQA Decoding” is set to “On”.
Analogue output (BALANCED/ UNBALANCED)	“Digital Output” is set to “Off”. “MQA Decoding” is set to “On”.

■ MQA Full Decoder

Digital output (COAX/OPT)	"Digital Output" is set to "On". "MQA Decoding" is set to "Off".
Analogue output (BALANCED/ UNBALANCED)	"Digital Output" is set to "Off". "MQA Decoding" is set to "On".

■ MQA is not supported

Digital output (COAX/OPT)	"Digital Output" is set to "On". "MQA Decoding" is set to "On".
Analogue output (BALANCED/ UNBALANCED)	"Digital Output" is set to "Off". "MQA Decoding" is set to "On".

- It is recommended that "MQA Decoding" is set to "On" when the connected digital output device supports MQA rendering function or does not support MQA function.
The digital signal outputs as MQA decoded signal (MQA Core) when "MQA Decoding" is set to "On" (The factory default is "On"). And the connected device renders the signal when the device supports MQA rendering function.
- It is recommended that "MQA Decoding" is set to "Off" when the connected digital output device provides MQA full decoding. The digital signal outputs as MQA bitstream without decoding when "MQA Decoding" is set to "Off", and the MQA full decoding device decodes all MQA signals.
- The MQA decoded signal (MQA Core) which is input to this unit, can be rendered and output as analogue signal when "MQA Decoding" is set to "On" and "Digital Output" is set to "Off". (Maximum upsampling limit is 192 kHz.)

Using the favourite function (FAV)

Registering your favourite station, music or playlist

You can register your favourite station, music or playlist (USB-A Front / USB-A Rear / DMP / Internet Radio / Spotify / TIDAL / Deezer / Qobuz, etc.) and call up the station.

- 1 Press [NWP].**
- 2 Switch the input source (USB-A Front / USB-A Rear / DMP / Internet Radio / Spotify / TIDAL / Deezer / Qobuz, etc.).**
- 3 Press and hold [PGM] while the playback screen is displayed.**
 - The favourite registering screen (FAV) is displayed.
- 4 Press [▲], [▼] repeatedly to select the number (FAV1 - 9) to register and then press and hold [OK].**
 - “Memorised” is displayed after registering.
 - You can register up to 9 favourite stations or playlists.
 - The favourite function (registering/calling up/deleting) can also be set from the dedicated application “Technics Audio Center” (free of charge).
 - Press and hold [PGM] for approx. 3 seconds to exit the setting.
 - You can also enter a favourite setting screen by pressing and holding [INPUT] on the unit.

Calling up the favourite station, music or playlist

- 1 Press [NWP].**
- 2 Press and hold [PGM].**
- 3 Press [▲], [▼] repeatedly to select a favourite number to play back and then press [OK].**
 - You can also select the number with the numeric buttons.
 - If no station or playlist is registered to the favourite list, “Empty” is displayed. Add a station or playlist to the list.
 - The input source automatically switches to the registered station.

Note

- If the station or playlist cannot be found after the input source is switched, playback does not start or other music may play back.

Deleting the favourite station, music or playlist

- 1 Press [NWP].
- 2 Press and hold [PGM].
- 3 Press [▲], [▼] repeatedly to select a favourite number to delete and then press [CLEAR].
- 4 Press [▲], [▼] repeatedly to select "Yes" and then press [OK].

- "Cleared" is displayed after deleting.
- "Empty" is displayed if no station or playlist is registered to the favourite list.

Operations using the dedicated app "Technics Audio Center"

If you install the dedicated app "Technics Audio Center" (free of charge) on your tablet/smartphone, you can control this unit and edit the favourite list. Download and install the app from the website below.

www.technics.com/support/

System control connection

You can operate this unit and Technics devices supporting system control function (Stereo Integrated Amplifier, etc.) simultaneously with ease on the remote control.

For details, refer to the operating instructions of each device.

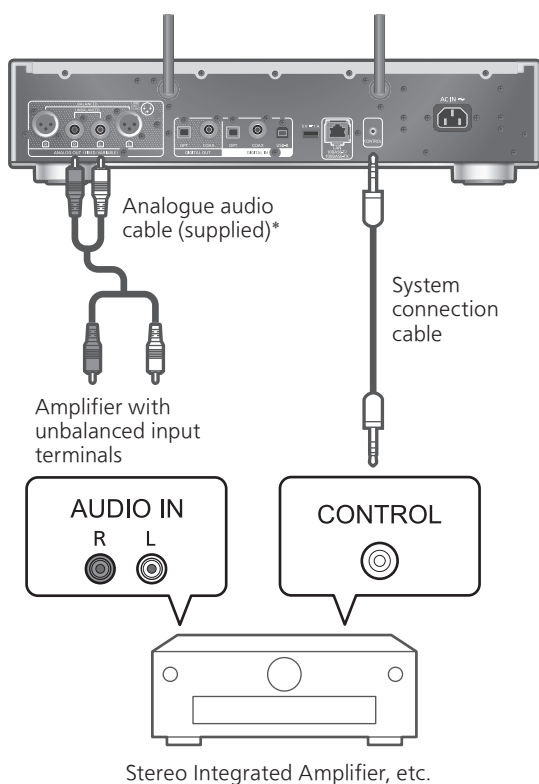

*: The illustration shows the example when connecting to an amplifier with unbalanced input terminals using analogue audio cable. Connect the device with proper cable/terminal supporting the device.

Note

- Be sure to connect the device with analogue audio cable when playing back Super Audio CD with this unit.
- System control function is not available when "A.Output Level" is set to "Variable".

Using system connection cable and audio cable

- 1 Disconnect the AC mains lead.**
- 2 Connect this unit and Technics device supporting system control function (Stereo Integrated Amplifier, etc.).**
 - Use both of the system connection cable and the audio cables when connecting this unit and the device.
 - Use the system connection cable supplied with the connected device.
- 3 Connect the AC mains lead to this unit. (⇒ 29)**
- 4 Press [NWP ⏻]/[CD ⏻] to turn this unit on.**
- 5 Set the system control function on the connected device.**
 - For details, refer to the operating instructions of the connected device.

Switching this unit and the connected device to on/standby simultaneously

When the device supporting system control function (Stereo Integrated Amplifier, etc.) is turned on/off, this unit is turned on/off automatically.

- 1 Press [NWP].**
- 2 Press [SETUP].**
- 3 Press [▲], [▼] repeatedly to select “Power On Link”/“Power Off Link” and then press [OK].**
- 4 Press [▲], [▼] to select “On” and then press [OK].**

Switching function for the input source of the connected device “Selector Link Type”

Set to “Adaptive” to switch the input source of the amplifier automatically to analogue input only when Super Audio CD is played back, regardless of the selected input of the amplifier (Technics devices supporting system control function).

- For details, refer to the following website.
www.technics.com/support/
- The factory default is “Normal”.

- 1 Press [NWP].**
- 2 Press [SETUP].**
- 3 Press [▲], [▼] repeatedly to select “Selector Link Type” and then press [OK].**
- 4 Press [▲], [▼] to select “On” and then press [OK].**

Adjusting BASS/MID/TREBLE “Tone Control”

You can adjust the tone of the SU-C700 with this unit. Each tonal range (BASS/MID/TREBLE) can be adjusted.

- 1 Press [NWP].**
- 2 Press [SETUP].**
- 3 Press [▲], [▼] repeatedly to select “Tone Control” and then press [OK].**
- 4 Press [▲], [▼] to set, and press [OK].**

- To enable this function, select “On (adjustment)”.
- Each level can be adjusted between “- 10” and “+ 10”.

Others

Troubleshooting.....	109
Heat buildup of this unit.....	109
Do you have the latest firmware installed?	109
To restore all the settings to the factory defaults.....	110
General	111
Disc.....	113
USB.....	113
Bluetooth®	114
Network.....	115
Spotify/TIDAL/Deezer/Qobuz/ Amazon Music /Internet Radio/ Podcasts	117
Remote control	118
Messages.....	118
Playable media.....	122
Notes on discs.....	122
USB.....	123
About Bluetooth®	124
Licenses.....	125
Specifications	127

 Table of contents ... 05

Troubleshooting

Before requesting service, make the following checks. If you are uncertain about some of the check points, or if the solutions indicated in the following guide do not resolve the issue, then consult your dealer for instructions.

Heat buildup of this unit

This unit becomes warm while in use.

- Be careful when touching the bottom of this unit because the bottom of this unit may be hot. For installation or unit care, disconnect the AC mains lead, wait for at least 3 minutes.

Do you have the latest firmware installed?

Panasonic is constantly improving the unit's firmware to ensure that our customers are enjoying the latest technology. (⇒ 97)

To restore all the settings to the factory defaults

When the following situations occur, reset the memory:

- There is no response when buttons are pressed.
- You want to clear and reset the memory contents.

1 Press [NWP] while this unit is turned on.

2 Press [SETUP].

3 Press [▲], [▼] repeatedly to select “Initialization” and then press [OK].

4 Press [▲], [▼] to select “Yes” and then press [OK].

- A confirmation screen appears. Select “Yes” in the following steps to restore all the settings to defaults.

5 Press [▲], [▼] to select “Yes” and then press [OK] again.

General

The unit does not work.

Operations are not done properly.

- One of the unit's safety devices, etc. may have been activated.
 - ① Press [⏻/⏻] on the unit to switch the unit to standby.
 - If the unit does not switch to standby, press [⏻/⏻] on the unit for at least 5 seconds. The unit is forcibly switched to standby. Alternatively, disconnect the AC mains lead, wait for at least 3 minutes, then reconnect it.
 - ② Press [⏻/⏻] on the unit to switch on. (It may take some time for this unit to be turned on.)
 - If the operations are not done properly yet even after turning this unit on, press and hold [⏻/⏻] at least 5 seconds to turn off, it may solve the problem.
 - If the unit still cannot be operated, consult the dealer.
- The remote control may not work properly. (⇒ 118)

A "humming" sound can be heard during playback.

- An AC mains lead of another device or fluorescent light is near the cables. Turn off other appliances, or keep them away from the cables of this unit.
- A strong magnetic field near a TV or other device may adversely affect the audio quality. Keep this unit away from such a location.
- The speakers may output noise when a device nearby is emitting powerful radio waves, such as when a mobile phone is on a call.

No sound.

- Check the volume of the connected device. Check the volume of this unit if "A.Output Level" is set to "Variable".
- Check to see if the cable connections to the input and output terminals are incorrect. If this is the case, turn this unit to standby and reconnect the cables correctly.
- Check to see if the correct input source is selected.
- Insert the plugs of the cables to be connected all the way in.
- Playback of multi-channel content is not supported.
- The digital audio input terminal of this unit can only detect linear PCM signals. For details, refer to the operating instructions of the device.
- Audio signal of Super Audio CD and Super Audio CD layer of Hybrid Super Audio CD cannot be output from the digital audio output terminal of this unit. Connect the device to the analogue audio output terminal.
- Not all MQA files may be played back. Set MQA decoding function to "Off" when is not played back properly. (⇒ 100)
- When MQA audio file cannot be played back properly, set "DSD Native" to "Off". The performance may be improved. (⇒ 91)
- Not all DSD signal may be played back. Set "DSD Native" to "Off" when is not played back properly. (⇒ 91)
- Check if "Digital Output" or "Analog Output" is set to "On". (⇒ 91)

Playback does not start.

- Depending on your environment or connected devices, it may take some time.
- Check to see if the format of the file is supported. For supported formats, refer to "Format". (⇒ 131)

The unit turns to standby mode automatically.

- Is the auto off function turned on? (⇒ 95)
- This unit may turn to standby mode simultaneously with the connected device with the system control function. (⇒ 106)

The settings are reset to the factory defaults.

- Updating the firmware may reset the settings.

The system control function is not working.

- Use the system connection cable supplied with the connected device.
- Connect the system connection cable to the system terminals (CONTROL). (⇒ 105)
- Set "A.Output Level" to "Fixed" (⇒ 105)
- Connect Technics device supporting system control function (Stereo Integrated Amplifier, etc.) to this unit. For details, refer to the following website.
www.technics.com/support/

The input source of connected device supporting system control function switches to an analogue input automatically.

- Set "Selector Link Type" to "Normal". (⇒ 107)

Disc

Incorrect display or play does not start.

- Make sure that the disc is compatible with this unit. (⇒ 122)
- There is moisture on the lens. Wait for about an hour and then try again.
- Unfinalised CD-R and CD-RW cannot be played back.
- WMA/MP3 is not supported. Refer to "Notes on discs" (⇒ 122) for information about the discs this unit can play back.

Playback takes time to start.

- It may take some time for the disc to load if there are a lot of tracks on it.

USB

The USB drive or its contents cannot be read.

- The USB drive format or its contents is/are not compatible with the unit. (⇒ 123)
- The USB drive may not be read which has the files/folders with the long names, even if the number of the files/folders of the USB device doesn't reach a maximum number (⇒ 129).

No response when [▶/III] is pressed.

- Disconnect the USB device and then reconnect it. Alternatively, turn the unit to standby and on again.

Slow operation of the USB flash drive.

- Large file size or high memory USB flash drive takes longer time to read.
- It may take some time if there are a lot of files or folders on it.

Cannot display the information properly.

- Track names, etc. may not be displayed properly.

Bluetooth®

Pairing cannot be completed.

- Check the Bluetooth® device condition.

The device cannot be connected.

- The pairing of the device was unsuccessful or the registration has been replaced. Try re-pairing the device. (⇒ 55)
- This unit might be connected to a different device. Disconnect the other device and try re-pairing the device.

The device is connected, but audio cannot be heard through this unit.

- For some built-in Bluetooth® devices, you have to set the audio output to this unit manually. Read the operating instructions for the device for details.

The sound is interrupted.

- The device is out of the 10 m communication range. Bring the Bluetooth® device closer to this system.
- Remove any obstacle between this system and the device.
- Other devices that use the 2.4 GHz frequency band (wireless router, microwaves, cordless phones, etc.) are interfering. Bring the Bluetooth® device closer to this system and distance it from the other devices.
- Select "Mode 1" for stable communication. (⇒ 58)

Network

Cannot connect to the network.

- Confirm the network connection and settings. (⇒ 30)
- If the network is set to be invisible, make the network visible while you set up the network for this unit or make a wired LAN connection.
- This system's Wi-Fi security supports WPA2™. Your wireless router must therefore be WPA2™ compatible. For details on the security supported by your router and how to change the settings, please refer to the operating instructions or contact your internet service provider.
- Make sure that the multicast function on the wireless router is enabled.
- Depending on the router, WPS button may not work. Try another connection method. (⇒ 34)
- The wireless LAN environment or radio interference in your area may cause connection problem. In this case, try another connection method. If the problem persists, make a wired LAN connection. (⇒ 32)
- While the AC mains lead is disconnected, the LAN cable must be connected or disconnected.

Cannot select this system as the output speakers.

- Make sure that the devices are connected to the same network as this unit.
- Reconnect the devices to the network.
- Turn the wireless router off and then on.
- Turn this unit to standby and on, and then select this system as the output speakers again.

Cannot select this unit from the Chromecast-enabled apps.

- When using the Chromecast-enabled apps to play music on this unit, you need to set up a network connection using Google Home app. (⇒ 36)
- You may not select this unit from the video apps, etc.

Playback does not start.

The sound is interrupted.

- The content may not be played back properly depending on the network condition.
- If using the 2.4 GHz band on the wireless router, simultaneous use with other 2.4 GHz devices, such as microwaves, cordless telephones, etc., may result in connection interruptions. Increase the distance between this unit and these devices.
 - If your wireless router supports 5 GHz band, try using the 5 GHz band.
- Do not place this system inside a metal cabinet, for it might block the Wi-Fi signal.
- If the playback stops, check the playback status on the device.
- Place this system closer to the wireless router.
- Check the Wi-Fi signal strength using “Signal Level” and adjust location of this unit and the wireless router. (⇒ 96)
- If several wireless devices are simultaneously using the same wireless network as this unit, try turning off the other devices or reducing their wireless network usage.
- Reconnect the devices to the network.
- Turn the wireless router off and then on.
- With some iOS and iTunes versions, it may not be possible to restart the AirPlay playback if the selector is changed (e.g. “CD”) or this unit is in standby mode, during the AirPlay playback. In this case, select a different device from the AirPlay icon of the Music App or iTunes and then re-select this system as the output speakers. (⇒ 86)
- If the above solutions do not solve the problem, make a wired LAN connection for all connected devices which have LAN terminal (this unit, Network Attached Storage, media server, etc.). (⇒ 32)

The media server and its contents are not displayed.

- The connected media server and its contents may not be displayed properly depending on its condition (e.g. soon after adding the contents to the server, etc.). Try again later. For details, refer to the operating instructions of the media server.

Cannot find music files stored on the PC.

- When you play back music files over a network, those that are not registered to its network server are not displayed. For details, refer to the operating instructions for your server.

Cannot display the information properly.

- Track names, etc. may not be displayed properly.

The content in PC, application, etc., cannot be played back.

- Depending on PC, application, etc., the content may not be played back even though the sampling frequency is supported. Check the PC, application, etc., to play back properly.

Spotify/TIDAL/Deezer/Qobuz/ Amazon Music /Internet Radio/ Podcasts

Playback does not start.

The sound is interrupted.

- The station that does not broadcast cannot be played back (or it will be skipped).
- The internet radio station may not be played back depending on the broadcasting method or the network condition.
- The content may not be played back properly depending on the network condition.
- Depending on the internet connection environment, the sound may be interrupted or it may take some time to play back.
- Service may not be available depending on the country or area.
- The services through Network Service are operated by their respective service providers, and service may be discontinued either temporarily or permanently without notice.
- Use the application for each music streaming service instead of this unit or "Technics Audio Center" to operate this unit, it may improve the performance.

Cannot display the information properly.

- Station names, countries, regions, genres, track names, album names, etc. which are managed by the service provider, may not be displayed properly depending on the broadcasting information.

Cannot call up the stations, musics or playlists registered in favourites function (FAV).

- The stations, musics or playlists may have been deleted or changed by the service provider. Register the station or playlist again.

A content different from the registered content is played back or may not be played back normally when calling favourites function (FAV).

- When it adds / calls a content in playlist as favourites function (FAV), a different content in playlist may be played back by the service provider.
- When it adds / calls a content as a favourites function (FAV), the title may not be displayed normally and it may not be played back normally by the service provider.

Remote control

The remote control does not work properly.

- Press [NWP] first to operate this unit. (The remote control works only for the devices supporting system control function when pressing [AMP].)
- The batteries are depleted or inserted incorrectly. (⇒ 24)
- To avoid interference, please do not put any objects in front of signal sensor. (⇒ 18)
- If the remote control mode of the remote control differs from that of this unit, match the mode of the remote control to the mode of this unit. (⇒ 24)

Messages

Auto Off

The unit has been left unused for about 20 minutes and will shut down within a minute. (⇒ 95) Press any button to cancel it.

Checking Device

The unit is checking the connected USB device.

- After this display has disappeared, start operating.

Connect to Network

Connect this unit to the network and then wait for the start of the Firmware Update via Internet. (⇒ 98)

Download Fail

The firmware download has failed.

The network is not connected to the internet.

- Press any button to exit. Please try again later.
- The server cannot be found. Press any button to exit. Make sure that the network is connected to the internet.

Empty

The selected folder is empty.

- Move tracks into the folder and retry the operation.

The server is not found on the network.

- Check to see if the server is connected to the same network as this unit, and retry the connection to this unit. (⇒ 30)

No station, track, etc. is registered to the favourite list or playlist.

- Add a station or track to the list. (⇒ 49, 103)

Error

Incorrect operation is performed.

- Read the instructions and try again.

Fail

Network connection is not complete.

- Try the setting again. (⇒ 30)

Firmware update is available

The firmware (free of charge) for this unit is available.

- ① Press [NWP].
- ② Press [OK].
- ③ Press [▲], [▼] to select "Yes" and then press [OK].
 - The progress is displayed as "Updating □ %" while updating. ("□" stands for a number.)
 - Do not disconnect the AC mains lead or turn this unit to standby while updating. (⇒ 97)
 - When the update has finished successfully, "Success" is displayed.
- ④ Press [⏻/⏻] on the unit to turn this unit off and on.

• For the update information, refer to the following website.

www.technics.com/support/firmware/

"F□□" ("□" stands for a number.)

An abnormality has occurred. (If this unit detects an abnormality, the protection circuit is activated, and the power may be turned off automatically.)

- Is this unit placed in an extremely hot place?
 - Wait a few seconds and then turn the unit on again. (The protection circuit will be deactivated.)
- If the problem persists, write down the displayed number, disconnect the AC mains lead and consult your dealer.

Load Fail

The firmware cannot be found on the USB flash memory.

- Download the latest firmware on the USB flash memory and try again. (⇒ 98)

No Device

No USB device is connected.

- Connect the USB device to be played. (⇒ 47)

USB device is not playable.

- Check to see if the file system of USB device is playable. (⇒ 129)

No Disc

No CD is inserted. Inserted CD-R, etc. have no audio track.

- Insert the disc to be played (⇒ 43).

No Layer

No available layer to be played back.

- Insert Hybrid Super Audio CD disc which has a CD layer and Super Audio CD layer.

No Network Available

This unit is not connected to the network.

- Check the network connection. (⇒ 30)

No Play

The disc cannot be played back.

- Insert the disc to be played (⇒ 122).

Not Valid

The function you have tried to use is not available with the current settings.

- Check the steps and settings.
- Registration/subscription may be required for some functions.
- Another input source than "CD" cannot be selected while this unit is in "Pure Disc Playback" mode. (⇒ 46)
- "Filter" cannot be changed in the following conditions. (⇒ 93)
 - While playing back Super Audio CD
 - "MQA Decoding" is set to "On".
 - "Coherent Processing" is set to "On".
 - While playing back DSD signal and "DSD Native" is set to "On".

Operate via App

Remote control is not available.

- Use the connected device or application for operating.

PGM Full

The number of programmed tracks is more than 20.

- No more track cannot be programmed.

Please Wait

This is displayed, for example, when this unit is turned to standby/on. (For up to approx. 1 minute and 30 seconds)

- Wait for the display disappears.

Reading

The unit is checking the CD information.

- After this display has disappeared, start operating.

"Remote □" ("□" stands for a number.)

The remote control and this unit are using different modes.

- Change the mode on the remote control. (⇒ 24)

Searching

The unit is checking the media server on the network.

- Check to see if there is a server in same network.

Unlocked

"COAX", "OPT" or "USB-B" is selected, but no device is connected or no audio is played back.

The sampling frequency components, etc. of the audio signals are not input correctly.

- Check the connection with the device. (⇒ 51)
- For supported formats, refer to "Format". (⇒ 131)

USB Over Current

USB device connected to the front/rear of this unit is drawing too much power.

- Disconnect the USB device and turn the unit to standby and on again. (⇒ 47)
- Turn this unit off and on.
- Check if there is no problem on the USB device. (⇒ 123)

Wi-Fi Setup

Select "Yes" and press [OK] to enter the network setting. (⇒ 33)

- To exit the network setting, select "No" and press [OK].

Playable media

Notes on discs

■ Disc formats supported by this unit

Super Audio CD	Support (2-channel only)
Commercially available CDs (CD-DA)	Support
CD-R/CD-RW (CD-DA)	Support

■ Compatible CD

- A disc with the CD Logo. 
- This unit can play back discs that conform to the CD-DA format.
- The unit may not be able to play some discs due to the condition of the recording.
- Before playback, finalise the disc on the device it was recorded on.

■ CDs that cannot be used

- CDs with irregular shapes, such as heart shapes (Use of such CDs may cause malfunction.)

■ CDs that are not guaranteed to operate with this unit

- Discs with illegally copied data and those that do not conform to industry standards
- DualDiscs (Discs that record data such as music and images on both sides)

■ This unit's lens

Use the lens cleaner (not supplied) to clean the unit's lens.

■ Clean discs



Wipe with a damp cloth and then wipe dry with a dry cloth.

■ Disc handling precautions

- Handle discs by the edges to avoid inadvertent scratches or fingerprints on the disc.
- Do not use disc cleaning sprays, benzene, thinner, static electricity prevention liquids or any other solvent.
- Do not attach labels or stickers to discs.
- Do not use the following discs:
 - Discs with exposed adhesive from removed stickers or labels (rented discs, etc.).
 - Discs that are badly warped or cracked.
 - Irregularly shaped discs, such as heart shapes.

USB

- This unit does not guarantee connection with all USB devices.
- FAT16, FAT32 and NTFS file systems are supported.
- This unit supports USB 2.0 high speed.
- USB devices may not be recognised by this unit when connected using the following:
 - a USB hub
 - a USB extension cable
- It is not possible to use USB card reader/writers.
- This unit cannot record music to a USB device.
- Not all files on the USB device may be read if there are some files not supported.
- About supported format, refer to “Format” (⇒ 131)

■ Folder and file structure

The unit plays back only the music files in the selected folder. Select the folder containing the tracks that you want to play back.

- Nothing is played back if you select a folder without music files, such as the folder **D** in the diagram below. (“Empty” is displayed.)

Example:

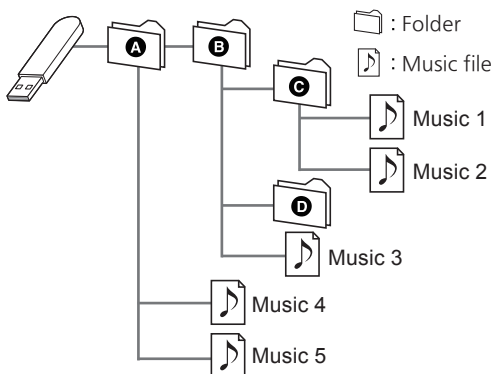

About Bluetooth®

Panasonic bears no responsibility for data and/or information that is compromised during a wireless transmission.

Frequency band used

- This system uses the 2.4 GHz frequency band.

Certification of this device

- This system conforms to frequency restrictions and has received certification based on frequency laws. Thus, a wireless permit is not necessary.
- The actions below are punishable by law in some countries:
 - Taking apart or modifying the system.
 - Removing specification indications.

Restrictions of use

- Wireless transmission and/or usage with all Bluetooth® equipped devices is not guaranteed.
- All devices must conform to standards set by Bluetooth SIG, Inc.
- Depending on the specifications and settings of a device, it can fail to connect or some operations can be different.
- This system supports Bluetooth® security features. But depending on the operating environment and/or settings, this security is possibly not sufficient. Transmit data wirelessly to this system with caution.
- This system cannot transmit data to a Bluetooth® device.

Range of use

- Use this device at a maximum range of 10 m. The range can decrease depending on the environment, obstacles or interference.

Interference from other devices

- This system may not function properly and troubles such as noise and sound jumps may arise due to radio wave interference if this system is located too close to other Bluetooth® devices or the devices that use the 2.4 GHz band.
- This system may not function properly if radio waves from a nearby broadcasting station, etc. is too strong.

Intended usage

- This system is for normal, general use only.
- Do not use this system near an equipment or in an environment that is sensitive to radio frequency interference (example: airports, hospitals, laboratories, etc.).

Licenses



The Wi-Fi CERTIFIED™ Logo is a certification mark of Wi-Fi Alliance®.

The Wi-Fi Protected Setup™ Logo is a certification mark of Wi-Fi Alliance®.



Use of the Works with Apple badge means that an accessory has been designed to work specifically with the technology identified in the badge and has been certified by the developer to meet Apple performance standards.

Apple and AirPlay are trademarks of Apple Inc., registered in the U.S. and other countries.

This product is compatible with AirPlay 2. iOS 11.4 or later is required.



Google, Google Home, and Chromecast built-in are trademarks of Google LLC.

Google Assistant is not available in certain languages and countries.

Windows is a trademark or a registered trademark of Microsoft Corporation in the United States and other countries.

Windows Media and the Windows logo are trademarks or registered trademarks of Microsoft Corporation in the United States and/or other countries. This product is protected by certain intellectual property rights of Microsoft Corporation and third parties. Use or distribution of such technology outside of this product is prohibited without a license from Microsoft or an authorized Microsoft subsidiary and third parties.

Mac and OS X are trademarks of Apple Inc., registered in the U.S. and other countries.

The Bluetooth® word mark and logos are registered trademarks owned by Bluetooth SIG, Inc. and any use of such marks by Panasonic Holdings Corporation is under license. Other trademarks and trade names are those of their respective owners.

“Super Audio CD” is a registered trademark.

SBM Direct is a registered trademark.

“DSD” is a registered trademark.

FLAC Decoder

Copyright (C) 2000, 2001, 2002, 2003, 2004, 2005, 2006, 2007, 2008, 2009 Josh Coalson

Redistribution and use in source and binary forms, with or without modification, are permitted provided that the following conditions are met:

- Redistributions of source code must retain the above copyright notice, this list of conditions and the following disclaimer.
- Redistributions in binary form must reproduce the above copyright notice, this list of conditions and the following disclaimer in the documentation and/or other materials provided with the distribution.
- Neither the name of the Xiph.org Foundation nor the names of its contributors may be used to endorse or promote products derived from this software without specific prior written permission.

THIS SOFTWARE IS PROVIDED BY THE COPYRIGHT HOLDERS AND CONTRIBUTORS “AS IS” AND ANY EXPRESS OR IMPLIED WARRANTIES, INCLUDING, BUT NOT LIMITED TO, THE IMPLIED WARRANTIES OF MERCHANTABILITY AND FITNESS FOR A PARTICULAR PURPOSE ARE DISCLAIMED. IN NO EVENT SHALL THE FOUNDATION OR CONTRIBUTORS BE LIABLE FOR ANY DIRECT, INDIRECT, INCIDENTAL, SPECIAL, EXEMPLARY, OR CONSEQUENTIAL DAMAGES (INCLUDING, BUT NOT LIMITED TO, PROCUREMENT OF SUBSTITUTE GOODS OR SERVICES; LOSS OF USE, DATA, OR PROFITS; OR BUSINESS INTERRUPTION) HOWEVER CAUSED AND ON ANY THEORY OF LIABILITY, WHETHER IN CONTRACT, STRICT LIABILITY, OR TORT (INCLUDING NEGLIGENCE OR OTHERWISE) ARISING IN ANY WAY OUT OF THE USE OF THIS SOFTWARE, EVEN IF ADVISED OF THE POSSIBILITY OF SUCH DAMAGE.

The Spotify Software is subject to third party licenses found here: <https://www.spotify.com/connect/third-party-licenses>.



MQA and the Sound Wave Device are registered trade marks of MQA Limited. © 2016

Specifications

■ GENERAL

Power supply	AC 220 V to 240 V, 50/60 Hz
Power consumption	45 W
Power consumption in standby mode (Network standby Off)	0.3 W
Power consumption in standby mode (Network standby On*1)	2.0 W
Dimensions (W×H×D)	430 mm × 98 mm × 407 mm
Mass	Approx. 12.3 kg
Operating temperature range	5 °C to 35 °C
Operating humidity range	35% to 80% RH (no condensation)

*1: Wired LAN or Wireless LAN

■ ANALOG OUTPUT SECTION

Channel	2 ch
Output level	
BALANCED	2.2 Vrms (Super Audio CD) / 2.2 Vrms (CD)
UNBALANCED	2.2 Vrms (Super Audio CD) / 2.2 Vrms (CD)
Frequency response	
Super Audio CD	2 Hz to 50 kHz (-3 dB)
CD	2 Hz to 20 kHz (-3 dB)
THD+N	
Super Audio CD	0.0006% (1 kHz, 0 dB)
CD	0.0015% (1 kHz, 0 dB)
S/N (IHF-A)	
Super Audio CD	BALANCED: 121 dB UNBALANCED: 118 dB
CD	BALANCED: 121 dB UNBALANCED: 118 dB
Dynamic range (IHF-A)	
Super Audio CD	BALANCED: 110 dB UNBALANCED: 110 dB
CD	BALANCED: 98 dB UNBALANCED: 98 dB

■ DISC SECTION

Disc played (8 cm or 12 cm)	Super Audio CD (2ch area only), CD, CD-R, CD-RW
Pick up	
Wavelength	650 nm (Super Audio CD), 790 nm (CD)
Laser power	CLASS 1
Audio Output (Disc)	2ch (FL, FR)
Format	Super Audio CD, CD-DA

NORSK

Bølgelengde	650 nm (Super Audio CD), 790 nm (CD)
Laserstyrke	Ingen farlig stråling sendes ut

■ Bluetooth® SECTION

Bluetooth® system specification	Bluetooth® Ver.4.2
Wireless equipment classification	Class 2 (2.5 mW)
Supported profiles	A2DP, AVRCP
Supported codec	AAC, SBC
Frequency band	2.4 GHz band FH-SS
Operating distance	Approx. 10 m Line of sight*2

*2: Prospective communication distance

Measurement environment:

Temperature 25 °C/Height 1.0 m

Measure in "Mode 1"

■ TERMINALS SECTION

Headphones Jack	Stereo, $\phi 6.3$ mm 110 mW, 32 Ω (VOL MAX)
USB-A (Front/Rear)	Type A Connector USB 2.0 High Speed DC 5 V 500 mA (Front) DC 5 V 1 A (Rear) USB Mass Storage Class
Support Memory Capacity	2 TB (max)
Maximum number of folders (albums)	800
Maximum number of files (songs)	8000
File system	FAT16, FAT32, NTFS
USB-B (Rear)	Type B Connector
Ethernet interface	LAN (100BASE-TX/10BASE-T)
Digital Input	
Optical digital input	Optical terminal
Coaxial digital input	Pin jack
Format support	LPCM
Analog output	
BALANCED	3 pin XLR
UNBALANCED	Pin jack
Digital output	
Optical digital output	Optical terminal
Coaxial digital output	Pin jack
Format support	LPCM
System port	
System control	$\phi 3.5$ mm, Jack

■ FORMAT SECTION

USB-A

USB Standard	USB 2.0 high-speed USB Mass Storage class
--------------	--

USB-B

USB Standard	USB 2.0 high-speed USB Audio Class 2.0, Asynchronous mode
DSD control mode	ASIO Native mode, DoP mode

■ Wi-Fi SECTION

Standard	IEEE802.11a/b/g/n/ac
Frequency band	2.4 GHz band 5 GHz band
Security	WPA2™
WPS version	Version 2.0

- The WLAN feature of this product shall exclusively be used inside buildings.

■ Format

This unit supports the following formats.

- This unit does not support the playback of copy-protected music files.
- Playback of all files in formats supported by this unit is not guaranteed.
- Playback of a file in a format not supported by this unit may cause choppy audio or noise. In such cases, check to see if this unit supports the file format.
- This unit does not support VBR (Variable Bit Rate) playback.
- Some of the connected devices or servers may be capable of converting files in formats not supported by this unit and output them. For details, refer to the operating instructions for your devices or servers.
- File information (sampling frequency, etc.) shown by this unit and playback software may differ from each other.
- Depending on PC, application, etc., the content may not be played back even though the sampling frequency is supported. Check the PC, application, etc., to play back properly.

USB-A

	Extension	Sampling frequency	Bit rate/ Number of quantisation bits
MP3	.mp3	32/44.1/ 48 kHz	16 to 320 kbps
AAC	.m4a .aac	32/44.1/48/ 88.2/96 kHz	16 to 320 kbps
WAV	.wav	32/44.1/48/ 88.2/96/ 176.4/192/ 352.8/384 kHz	16/24/32 bit
FLAC	.flac	32/44.1/48/ 88.2/96/ 176.4/192/ 352.8/384 kHz	16/24 bit
AIFF	.aiff	32/44.1/48/ 88.2/96/ 176.4/192/ 352.8/384 kHz	16/24/32 bit
ALAC	.m4a	32/44.1/48/ 88.2/96/ 176.4/192/ 352.8/384 kHz	16/24 bit
DSD	.dff .dsf	2.8/5.6/ 11.2 MHz	

USB-B

	Extension	Sampling frequency	Bit rate/ Number of quantisation bits
DSD	.dff .dsf	2.8/5.6/ 11.2 MHz	
PCM		32/44.1/48/ 88.2/96/ 176.4/192/ 352.8/384 kHz	16/24/32 bit

LAN (DMR)*3

	Extension	Sampling frequency	Bit rate/ Number of quantisation bits
MP3	.mp3	32/44.1/ 48 kHz	16 to 320 kbps
AAC	.m4a .aac	32/44.1/48/ 88.2/96 kHz	16 to 320 kbps
WAV	.wav	32/44.1/48/ 88.2/96/ 176.4/192/ 352.8/384 kHz	16/24/32 bit
FLAC	.flac	32/44.1/48/ 88.2/96/ 176.4/192/ 352.8/384 kHz	16/24 bit
AIFF	.aiff	32/44.1/48/ 88.2/96/ 176.4/192/ 352.8/384 kHz	16/24/32 bit
ALAC	.m4a	32/44.1/48/ 88.2/96/ 176.4/192/ 352.8/384 kHz	16/24 bit
DSD	.dff .dsf	2.8/5.6/ 11.2 MHz	

*3: Whether or not each music file can be played back over your network is determined by the network server even if the format of the file is listed above. For example, if you are using Windows Media Player 11, not all music files on the PC are playable. You can play back only those added to the library of Windows Media Player 11.

Note

- Specifications are subject to change without notice.
- Mass and dimensions are approximate.

EU



**Importer for UK:
Panasonic UK, a branch of
Panasonic Marketing Europe GmbH
Maxis 2, Western Road, Bracknell,
Berkshire, RG12 1RT**

**Headquarter Address:
Panasonic Corporation
1006 Oaza Kadoma, Kadoma City,
Osaka 571-8501, Japan**

**Authorized Representative in Europe:
Panasonic Marketing Europe GmbH
Panasonic Testing Centre
Winsbergring 15, 22525 Hamburg,
Germany**

Panasonic Corporation

Web Site: <http://www.panasonic.com>

© Panasonic Corporation 2022

Ⓔ

TQBM0848
M1122YY0